

HUMA

H5 V2.1

USER MANUAL

BENUTZERHANDBUCH

KULLANIM KILAVUZU

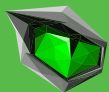
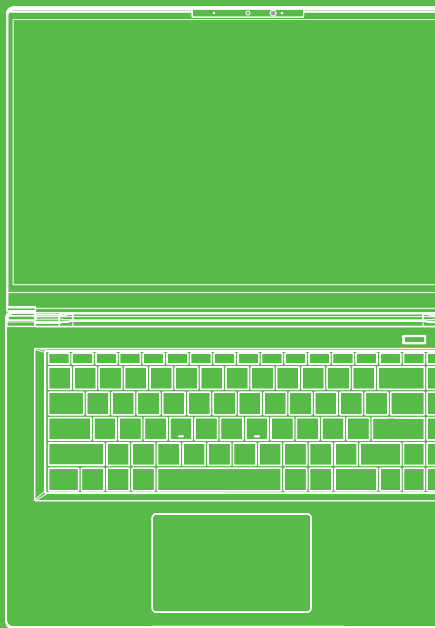

MONSTER

TABLE OF CONTENT

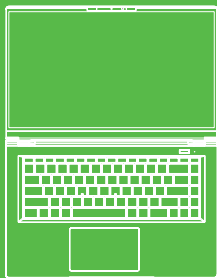

CHAPTER 1 - Preface	02
1.1 Regulations Information	02
FCC Information	03
RF Exposure Information[SAR]	04
1.2 Safety Information	05
1.3 Conventions For This Manual	06
CHAPTER 2 - Getting To Know The Basics	06
2.1 Product Specification	06
2.2 Preparing your Computer	08
2.3 Product Overview	09
CHAPTER 3 - Getting Started	14
3.1 AC Adapter	14
3.2 Knowing The Keyboard	15
3.2.1 For Keyboard Users	15
3.3 Using the touchpad / clickpad	17
3.3.1 Touchpad Usage	18
CHAPTER 4 - Bios Setup	18
4.1 About Bios Setup	18
4.1.1 When To Use Bios Setup?	18
4.1.2 How to Run BIOS Setup ?	19
4.2 BIOS Setup Menu	19
4.2.1 Main Menu	20
4.2.2 Advanced Menu	21
4.2.3 Security Menu	22
4.2.4 Boot Menu	23
4.2.5 Exit Menu	23

HUMA
H5 V2.1

USER
MANUAL

NOTICE

The information in this user's manual is protected by copyright laws, all parts of this manual, including the products and software described in it, can not be reproduced, transmitted, transcribed, stored in a retrieval system, nor translated into any language.

THE MANUFACTURER OR RESELLER SHALL NOT BE LIABLE FOR ERRORS OR OMISSIONS CONTAINED IN THIS MANUAL AND SHALL NOT BE LIABLE FOR ANY CONSEQUENTIAL DAMAGES, WHICH MAY RESULT FROM THE PERFORMANCE OR USE OF THIS MANUAL.

The illustrations in this user's manual are for reference only. Actual product specifications may vary with territories. The information in this user's manual is subject to change without notice.

CHAPTER 1

Preface

1.1 Regulations Information

- CE compliance

This device is classed as a technical information equipment [ITE] in class B and is intended for use in living room and office. The CE-mark approves the conformity by the EU-guidelines:

- EMC Directive 2014/30/EU,
- Low Voltage Directive 2014/35/ EU[equals A2 : 2013],
- RF Directive 2014/53/EU



The unit can be operated at an ambient temperature of max. 35°C [95°F]. Do not subject it to temperatures below 5°C [41°F] or above 40°C [104 °F].

CAUTION: RISK OF EXPLOSION IF BATTERY IS REPLACED BY AN INCORRECT TYPE DISPOSE OF USED BATTERIES ACCORDING TO THE INSTRUCTIONS



PREVENTION OF HEARING LOSS

CAUTION: Listening to music at high volume levels and for extended durations can damage one's hearing. In order to reduce the risk of damage to hearing, one should lower the volume to a safe, comfortable level, and reduce the amount of time listening at high levels. Headsets should comply with EN 50332-2 requirements.

FCC Information

FEDERAL COMMUNICATIONS COMMISSION INTERFERENCE STATEMENT

This equipment has been tested and found to comply with the limits for a Class B digital device, pursuant to part 15 of the FCC Rules. These limits are designed to provide reasonable protection against harmful interference in a residential installation. This equipment generates, uses and can radiate radio frequency energy and, if not installed and used in accordance with the instructions, may cause harmful interference to radio communications. However, there is no guarantee that interference will not occur in a particular installation. If this equipment does cause harmful interference to radio or television reception, which can be determined by turning the equipment off and on, the user is encouraged to try to correct the interference by one or more of the following measures:

- Reorient or relocate the receiving antenna.
- Increase the separation between the equipment and receiver.
- Connect the equipment into an outlet on a circuit different from that to which the receiver is connected.
- Consult the dealer or an experienced radio/TV technician for help.



CAUTION: Any changes or modifications not expressly approved by the grantee of this device could void the user's authority to operate the equipment.

RF Exposure Information [SAR]

This device meets the government's requirements for exposure to radio waves. This device is designed and manufactured not to exceed the emission limits for exposure to radio frequency [RF] energy set by the Federal Communications Commission of the U.S. Government.

The exposure standard employs a unit of measurement known as the Specific Absorption Rate, or SAR. The SAR limit set by the FCC is 1.6 W/kg. Tests for SAR are conducted using standard operating positions accepted by the FCC with the EUT transmitting at the specified power level in different channels.

The FCC has granted an Equipment Authorization for this device with all reported SAR levels evaluated as in compliance with the FCC RF exposure guidelines. SAR information on this device is on file with the FCC and can be found under the Display Grant section of www.fcc.gov/eot/ea/fccid after searching on FCC ID: 2AKHFAX201NG.

This device complies with Part 15 of the FCC Rules. Operation is subject to the following two conditions:

- [1] this device may not cause harmful interference, and
- [2] this device must accept any interference received, including interference that may cause undesired operation.



CAUTION: Any changes or modifications not expressly approved by the grantee of this device could void the user's authority to operate the equipment.

1.2 Safety Information

**1**

Do not apply heavy pressure to the computer or subject it to any form of strong impact as this can damage the computer's components or otherwise cause it to malfunction.

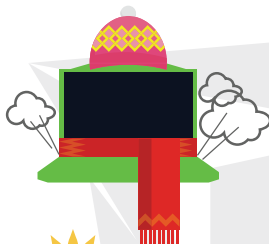
**2**

Never cover or block the air vents including those located at the base of the computer. Never cover your computer or AC adaptor with any object.

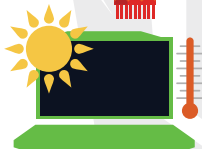
**3**

To keep your computer in prime operating condition, protect your work area from direct sunlight.

**4**

Do NOT expose to or use near liquid, rain, or moisture.
Do NOT use the modem during electrical storms.

**5**

Do not use or expose this device around magnetic fields as magnetic interference may affect the performance of the device.

1.3 Conventions For This Manual



CAUTION: This message contains important information that must be followed for safe operation.

NOTE: This message contains information for special situations.

CHAPTER 2

Getting To Know The Basics

2.1 Product Specification

This User's Manual provides technical information of instructions and illustrations on how to operate this notebook for the customer. Please read this manual carefully before using this notebook.

Physical Characteristic

Dimension	356,4mm x 233,73mm x 16,8mm
Weight	1,55 kg +/- 5%

Processor - CPU

Support Processor	10. Generation i7 10750H
-------------------	--------------------------

Graphic Card - GPU

Graphic Card	4 GB GDDR6 nVIDIA® GeForce® GTX 1650
--------------	--------------------------------------

Bellek

DDR4	DDR4 2933MHZ
------	--------------

Storage

HDD	2,5" Sata HDD 7mm
SSD	2 Slot (Only Support one M.2 Sata SSD) M2 2280 Slot 1: NVMe/PCIEX4 Slot 2: NVMe / PCIEX4 / SATAX1 RAID 0/1 Support

Webcam

Webcam	IR camera with D-MIC*2
--------	------------------------

I/O Port

DC-In	x1
USB	x2 USB 3.1 [Gen1] x1 USB 3.1 Type C [Gen1] x1 USB 2.0
RJ45	x1
Card Reader	x1 [SD/SDHC/SDXC]
HDMI	x1
Audio Out	x1
Microphone In	x1

Audio

Audio Codec	Azalia standard support, D3 mode support, Smart AMP support
Speaker	Build-in 2 speakers [2W / Each]
Microphone	Digital Microphone Support

Input

Keyboard	Membrane Keyboard backlight support
Pointing Device	TDA1470 114.5x70x0.8mm

Display

LCD	15,6" FHD, 16:9 Narrow Border
------------	-------------------------------

Communication Port

Lan	Supports 10/100/1000 Mb/Sec, DSM [Deep sleep mode] support
Wireless Lan	M.2 2230 w/ CNVI interface [Intel WiFi6 AX series] IEEE802.11AX mode support,

Power

AC Adapter	Automatics Voltage adjustment between 100 and 240V AC 50/60Hz, 90 Watts [19V/4,74A],
Battery	Li- polymer Battery, soft pack, 6 cells [3S2P 7900mAh] 91.24 Wh



CAUTION: MODEL IS DESIGNED TO USE WITH THE
DC INPUT: 90 Watts 19V / 4.74A

NOTE Please use the match adapter basing on the rating of BIOS, to avoid
overheat and abnormal of adapter.

2.2 Preparing your Computer

- A** Connect the AC adaptor's DC output plug to the DC IN jack.

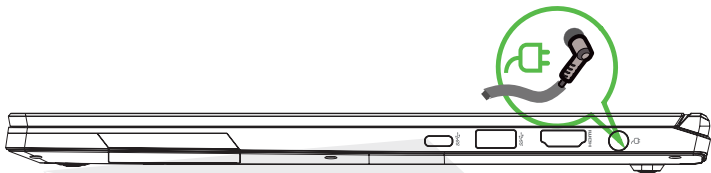

- B** The display panel can be opened to a wide range of angles for optimal viewing.

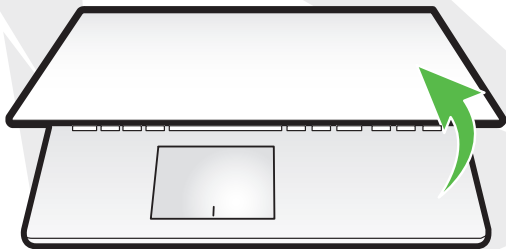

- C** Press the power button to turn on your notebook computer.

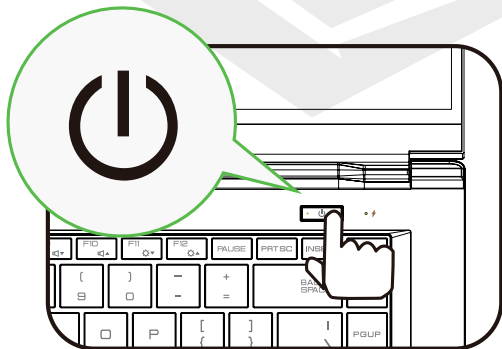

2.3 Product Overview

Please become familiar with each component before you operate the computer.

Top-Open View

NOTE

The product's color/ LED color, I/O port, indicator location, and specification will depend upon the actually shipping product.

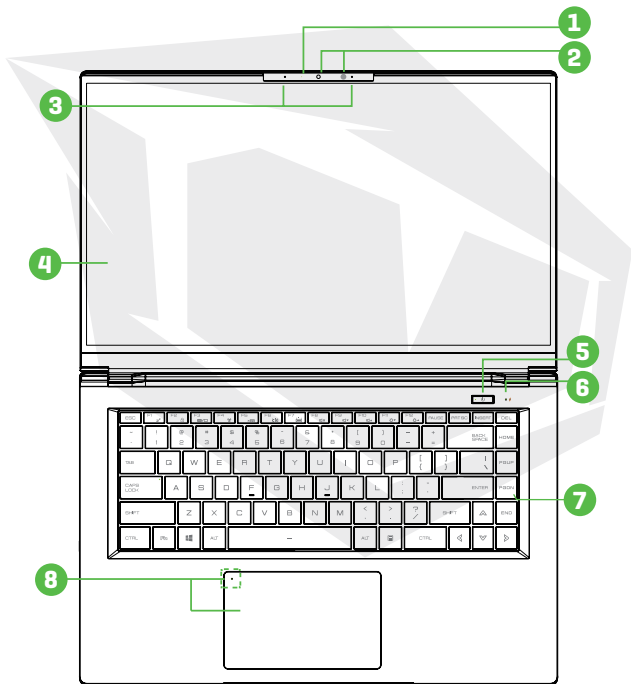

CAUTION: When you are not using the computer, keep the LCD screen closed to protect it from dust.

1 Camera Status Led

The Camera Status LED shows the Camera status.

2 Webcam

A device that allows you to record video or take photographs with your computer.

Infrared capability for facial recognition camera

[Optional] can be used to identify and authenticate user to unlock notebook, conduct payment and other security functions.

3 Microphone

Built-in microphone. IR CCD MIC*2[Optional]

4 LCD Screen

Displays of your notebook computer.

5 Power Button

Press this button to turn the computer's power on or off.

Power ON: White **Power Off:** OFF

Suspend: White, Slow/Smooth, Blinking White [3Sec/Cycle]

6 Charging & Battery indicator

Charging[Power ON]: White **Charging[Power Off]:** White,

Battery Low [<6%]: Orange [3 Sec/Cycle]

Charging finish [w/AC]: White ,(w/o AC): Off

7 Keyboard

Membrane keyboard

[The keyboard legend will depend on the spec / region]

8 Touchpad/Click pad

Touch-sensitive pointing device which functions like the mouse.

Touchpad LED indicator/ Touchpad switch

Front Side View



Bottom Side View

NOTE

The product's thermal vent will depend upon the actually shipping product.

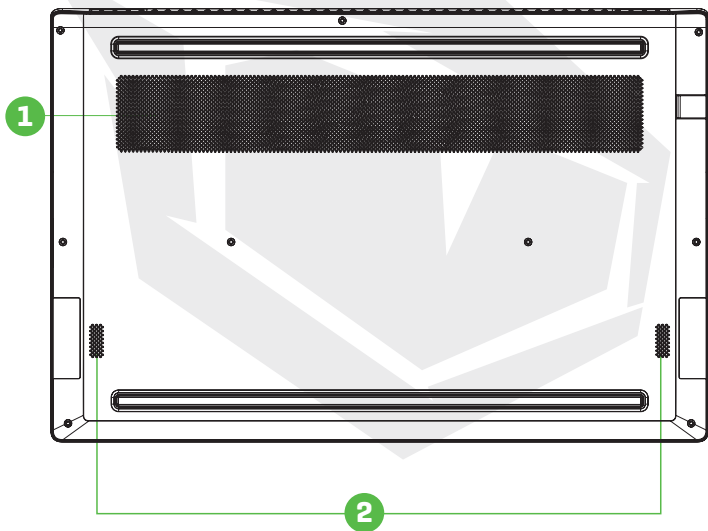

1 Vents

The thermal vents are designed to cool the internal components and avoid overheating.

2 Speakers

RAM / SSD / WLAN Compartment View

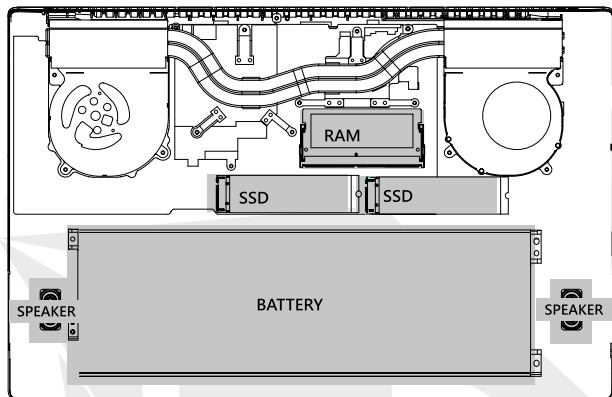

If need to upgrade SATA SSD to PCIE SSD, Please contact technical support and after-sales service .



CAUTION:

To reduce the possibility of heat-related injuries or of overheating the computer, Do not place the computer directly on your lap or obstruct the computer air vents. Use the computer only on a hard, flat surface.

Right Side View



1 USB Ports [Type-C]

Support 90W Type-C Adaptor 19V/4.7A
Connects an USB device.

2 USB Ports

Connects an USB device.

3 HDMI Port

Connected to the screen, or home theater system.

4 Power Connector

Connects the AC adaptor into this connector.

Left Side View

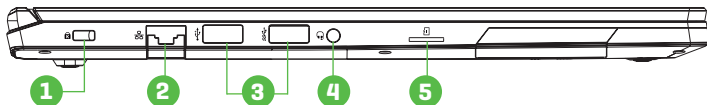

- 1 Kensington® Lock Port** 

To be secured using Kensington® Lock Port security products.
- 2 Network Jack** 

This jack lets you connect to a LAN.
- 3 USB Ports** 

Connects an USB device.
- 4 Audio Out Jack and Microphone Jack** 

Connects amplified speakers, headphones or microphone into this jack.
- 5 Card Reader** 

Insert memory card.

Back Side View

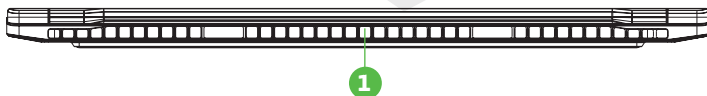

- 1 Vents**

The thermal vents are designed to cool the internal components and avoid overheating.

CHAPTER 3

Getting Started

3.1 AC Adapter

Please be noted that it is strongly recommended to connect the AC adapter and use the AC power while using this notebook for the first time. When the AC adapter is connected, the battery is being charged immediately. Attach the AC adapter when you need to charge the battery or you want to operate from AC power. It is also the fastest way to get started, because the battery pack will need to be charged before you can operate from battery power.

Note that the AC adapter included in the package is approved for your notebook; using other adapter model may damage either the notebook or other devices attached to it.

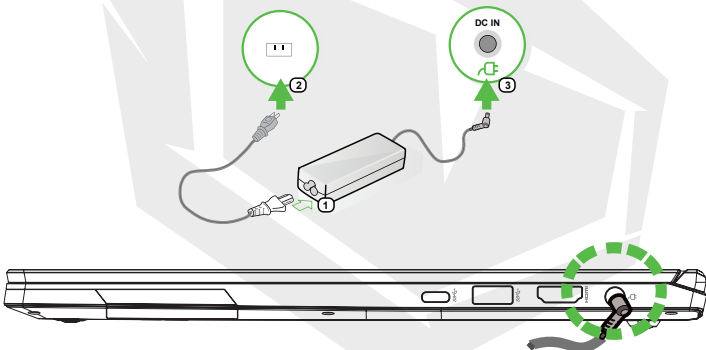

CAUTION:

The use of inferior extension cords may result in damage to your notebook. Your notebook comes with its own authorized AC adapter. Use of a different AC adapter or cable extension which is not authorized for use will void warranty protection if damage to hardware is found in association to said adapter or extension cable.

NOTE

The power adapter may become warm to hot when in use. Be sure not to cover the adapter and keep it away from your body. Your adapter might look different depend on your region.

3.2 Knowing The Keyboard

The following defines the colored hot keys on the Keyboard. The colored commands can only be accessed by first pressing and holding the function key while pressing a key with a colored command.



































NOTE

The number of keys available on your keyboard will depend on the country/region in which the keyboard was designed and built.

3.2.1 For Keyboard Users

To activate these functions, press the hot key associated with the desired function as below:

Keypad	Function Description
 +  Suspend:	Press this key combination [Fn+F1] to enter sleep mode.
 +  Windows Lock/On:	Press this key combination [Fn+F2] to turn Windows Lock/On .
 +  Display Mode:	Press this key combination [Fn+F3] to enable Display Mode.
 +  RADIO On/Off:	Press this key combination [Fn+F4] to turn all radios on or off.
 +  Touch pad On/Off:	Press this key combination [Fn+F5] to On/ Off Touch pad mode.

Keypad	Function Description
 +  Keyboard Brightness down:	Press this key combination [Fn+F6] to decrease brightness of Keyboard.
 +  Keyboard Brightness up:	Press this key combination [Fn+F7] to increase brightness of Keyboard.
 +  MUTE:	Press this key combination [Fn+F8] to enter MUTE mode.
 +  Volume down:	Press this key combination [Fn+F9] to enter Volume down mode.
 +  Volume up:	Press this key combination [Fn+F10] to enter Volume up mode.
 +  Brightness down:	Press this key combination [Fn+F11] to decrease brightness of LCD display.
 +  Brightness up:	Press this key combination [Fn+F12] to increase brightness of LCD display.
 +  Search Charm:	Press this key combination [Windows logo key+Q] to open the search charm and search apps.
 +  Settings Charm	Press this key combination [Windows logo key+I] to open the settings charm.
 +  Share Charm :	Press this key combination [Windows logo key+H] to open the share charm.
 +  Devices Charm:	Press this key combination [Windows logo key+K] to open the devices charm.

3.3 Using the touchpad / clickpad

The touchpad/clickpad is a rectangular electronic panel located just below your keyboard. You can use the static-sensitive panel of the touchpad/clickpad and slide it to move the cursor. You can use the buttons below the touchpad as left and right mouse buttons.

Press the left **1** and right **2** buttons located on the edge of the touchpad/clickpad to make selections and run functions. These two buttons are similar to the left and right buttons on a mouse. Tapping on the touchpad/clickpad produces similar results.

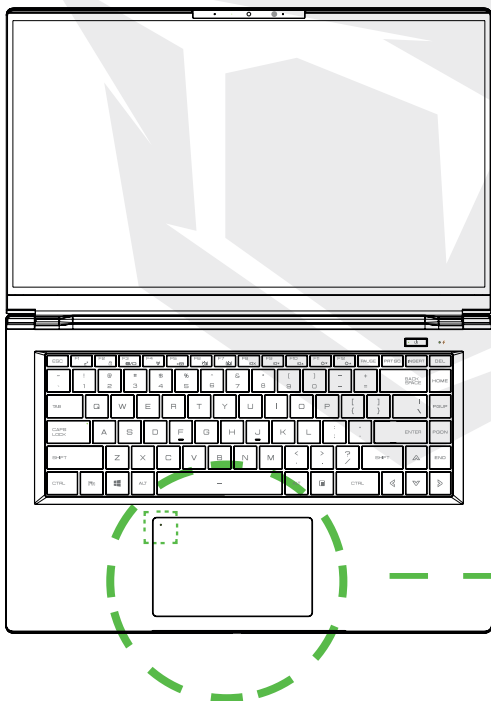

Click twice will open or close [Green light] touchpad functionality

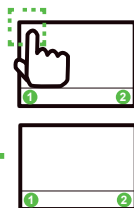

3.3.1 Touchpad Usage

Touch Pad Gesture

Modern touchpad gesture:

A modern touchpad should support the core touch gestures described in the following table.

Item	Gesture Name	Gesture
1	One Finger	 Left Click - Double Click
2		 Move Cursor
3		 Tap + Slide
4	Two Finger	 Scroll / Pan
5		 Pinch - Zoom
6	Three Finger	 Multitasking Gesture

CHAPTER 4

Bios Setup

4.1 About Bios Setup

4.1.1 When To Use Bios Setup?

You may need to run the BIOS Setup when:

- An error message appears on the screen during the system booting up and is requested to run SETUP.
- You want to change the default settings for customized features.
- You want to reload the default BIOS settings.

4.1.2 How to Run BIOS Setup?

To run the BIOS Setup Utility, turn on the notebook and press the [Del] key during the POST procedure.

If the message disappears before you respond and you still wish to enter Setup, either restart the system by turning it OFF and ON, or simultaneously pressing [Ctrl]+[Alt]+[Del] keys to restart.

Be noted that the screen snaps and setting options in this chapter are for your references only. The actual setting screens and options on your Notebook may be different because of BIOS update.

The setup function only can be invoked by pressing [Del] or [F2] key during POST that provide a approach to change some setting and configuration the user prefer, and the changed values will save in the NVRAM and will take effect after the system rebooted. The setup uses a menu interface to allow the user to configure their system and the features are briefly listed as follow.

Press [F7] key for Boot Menu.

NOTE

The drivers, BIOS and utilities bundled in the support DVD may vary by models and are subject to change without notice.

4.2 BIOS Setup Menu

Once you enter the BIOS Setup Utility, the Main Menu will appear on the screen. Select the tags to enter the other menus.

Main Menu	Show system overview about memory size and setting of system time and date.
Advanced Menu	To select the XD feature enable or disable XD feature only work with Intel platform + Windows.
Security Menu	Install or clear the password settings for supervisor and user.
Boot Menu	Configure Settings during System Boot.
EXIT Menu	Save or discard the changes before leaving the BIOS Setup Menu.

4.2.1 Main Menu

```

Apilo Setup Utility - Copyright (C) 2018 American Megatrends, Inc.
Main Advanced Security Boot Exit

System Information

System Time                [17:57:13]
System Date                [Mon 03/05/2018]

BIOS Version              B.0.06
EC Version                0.24.01
Build Date and Time      03/01/2018 13:49:45
Manufacturer Name       Standard
Product Name            Standard
Serial Number           Standard
Asset Tag               Standard
UUID Number            00020003000400050006000700080009
Ethernet MAC Address    B0:25:AA:26:6F:5B

Processor
Processor Type           Intel(R) Core(TM) i7-8750H CPU @ 2.20GHz
Processor Speed         2200 MHz

Total Memory             8192 MB
Memory Frequency        2400 MHz

ME Information
ME FW Version           12.0.0.1050
ME Firmware SKU        Consumer SKU

Version 2.20.1271. Copyright (C) 2018 American Megatrends, Inc.

```

• System Time

This item allows you to set the system time. There is a small internal [CMOS] battery which is designed to maintain your system clock. It is designed to maintain time even when the PC is powered down or in sleep mode. The time format is [hour:minute:second].

Use [+] or [-] to configure system Time.

• System Date

This item allows you to set the system date. The date format is [day:month:date:year]. Use [ENTER], [TAB] or [SHIFT-TAB] to select a field.

Day

Day of the week, from Sun to Sat, which is determined by BIOS [read-only].

Month

[Month] The month from 01 [January] to 12 [December].

Date

[Date] date from 01 to 31.

Year

[Year] The year can be adjusted by users.

• Total Memory

This allows you to see the total amount of memory.

4.2.2 Advanced Menu

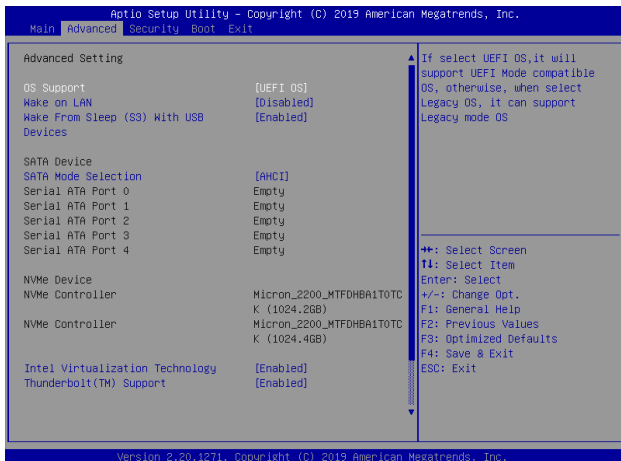

- **Wake From Sleep [S3] With USB Devices:** Enable/Disable wake from sleep [S3] with USB devices.
- **Serial ATA HDD:** It will show AHCI SATA HDD info.
- **NVMe Device:** It will show NVMe Device info.
- **Intel Virtualization Technology:** When enabled, a VMM can utilize the additional hardware capabilities provided by Vanderpool Technology.
- **RAID mode reminder:** Please update strip size in BIOS to 128K in order for RAID to optimize performance.
- **Thunderbolt(TM) Support :** [Enabled/ Disabled]
- **OverClocking Feature:** Performance Menu for Processor and Memory. [Disabled/Enabled]
- **Core Voltage Offset:** [50] Specifies the Offset Voltage applied to the IA Core domain. This voltage is specified in millivolts. Uses Mailbox MSR 0x150, cmd 0x11. Range -500 to 500 mV.
- **XTU Interface:** [Enabled]
- **Offset Prefix [+/-]**

4.2.3 Security Menu

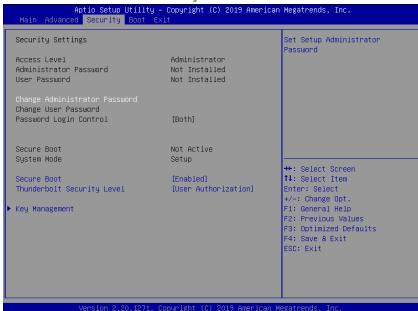

• Change Administrator Password

When this item is selected, a message box shall appear on the screen as below:

Enter New Password

- Type a maximum of 20-digit password and press [Enter].
- The password typed now will replace any previously set password from CMOS memory. You may also press [ESC] to abandon new password setting. It is extremely important to keep record for any BIOS password which is set as it can not be reset even with the removal of a CMOS battery for the security of your PC.
- Select Change User Password to give or to abandon password setting same as Change Administrator Password item above.
- Note that Administrator Password field allows users to enter and change the settings of the BIOS SETUP UTILITY, while User Password field only allows users to enter the BIOS SETUP UTILITY without having the authorization to make any change.
- The Password Check item is used to specify the type of BIOS password protection that is implemented.
- To clear a set Administrator Password/ User Password, just press [Enter] under Change Administrator Password/ Change User Password field when you are prompted to enter the password. A message box will pop up confirming password will be disabled. Once the password is disabled, the system will boot and user can enter setup without entering password.

• Key Management:

Enables expert user to modify Secure Boot Policy variables without full authentication.

4.2.4 Boot Menu

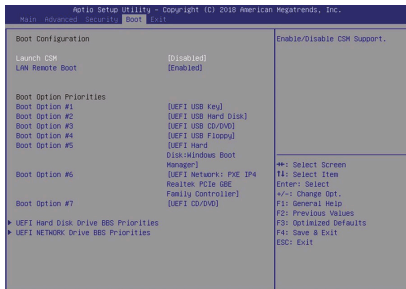

- **Boot Configuration:**
Configure Settings during System Boot.

- **LAN Remote Boot [Disabled]:**
Boot from LAN or not.

- **Set Boot Priority**

Specifies the boot sequence from the available devices. A device enclosed in parenthesis has been disabled in the corresponding type menu.

- **Hard Disk Drive / USB Hard Disk Drive**

Specifies the Boot Device Priority sequence.

4.2.5 Exit Menu

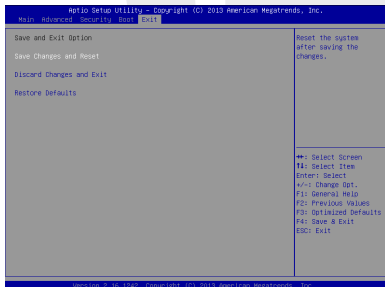

- **Save Changes and Reset**

Exit system setup after saving the changes. F4 key can be used for this operation.

- **Discard Changes and Exit**

Exit system setup without saving any changes. ESC key can be used for this operation.

- **Restore Defaults**

Restore/Load Defaults values for all the setup options. F3 key can be used for this operation.

INHALTSVERZEICHNIS

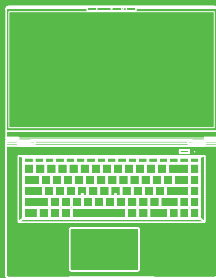

KAPITEL 1 – Einführung	26
1.1 Informationen zu den Bestimmungen.....	26
FCC-Informationen	27
Informationen zur RF-Exposition [SAR]	28
1.2 Sicherheitshinweise	29
1.3 Anmerkungen zu diesem Handbuch	30
KAPITEL 2 – Kennenlernen der Grundlagen	30
2.1 Produktbeschreibung	30
2.2 Vorbereiten Ihres Computers.....	32
2.3 Produktübersicht	33
KAPITEL 3 – Erste Schritte	38
3.1 AC-Adapter [Netzgerät]	38
3.2 Die Tastatur kennenlernen.....	39
3.2.1 Für Tastaturbenutzer.....	39
3.3 Verwendung des Touchpads/Clickpads.....	41
3.3.1 Benutzung des Touchpads.....	42
KAPITEL 4 – BIOS-Setup	42
4.1 Über BIOS-Setup.....	42
4.1.1 Wann wird das BIOS-Setup verwendet?.....	42
4.1.2 Wie wird das BIOS-Setup ausgeführt?	43
4.2 BIOS-Einrichtungsmenü	43
4.2.1 Hauptmenü	44
4.2.2 Erweitertes Menü.....	45
4.2.3 Sicherheits-Menü.....	46
4.2.4 Boot-Menü	47
4.2.5 Menü verlassen	47

HUMA
H5 V2.1

BENUTZERHANDBUCH

HINWEIS

Die Informationen in diesem Benutzerhandbuch sind urheberrechtlich geschützt. Alle Teile dieses Handbuchs, einschließlich der darin beschriebenen Produkte und Software, dürfen weder reproduziert, übertragen, transkribiert, in einem Retrieval-System gespeichert noch in eine andere Sprache übersetzt werden.

DER HERSTELLER ODER HÄNDLER HAFTET NICHT FÜR FEHLER ODER AUSLASUNGEN IN DIESEM HANDBUCH UND IST NICHT HAFTBAR FÜR FOLGESCHÄDEN, DIE SICH AUS DER DURCHFÜHRUNG ODER DEM GEBRAUCH DIESES HANDBUCHS ERGEBEN KÖNNEN.

Die Abbildungen in diesem Benutzerhandbuch dienen nur als Referenz. Die tatsächlichen Produktspezifikationen können je nach Gebiet variieren. Die Informationen in diesem Benutzerhandbuch können ohne Vorankündigung geändert werden.

KAPITEL 1

Einführung

1.1 Informationen zu den Bestimmungen

- CE-Konformität

Dieses Gerät ist als technisches Informationsgerät [ITE] der Klasse B eingestuft und ist für den Einsatz in Wohnraum und Büro vorgesehen. Das CE-Zeichen bestätigt die Konformität mit den EU-Richtlinien:

- EMV-Richtlinie 2014/30/EU,
- Niederspannungsrichtlinie 2014/35/EU (entspricht A2: 2013),
- RF-Richtlinie 2014/53/EU



Das Gerät kann bei einer Umgebungstemperatur von max. 35°C [95°F] betrieben werden. Setzen Sie es nicht Temperaturen unter 5°C [41°F] oder über 40°C [104 °F] aus.

WARNUNG: EXPLOSIONSGEFAHR, WENN DIE BATTERIE DURCH EINEN FALSCHEN TYP ERSETZT WIRD. ENTSORGEN SIE GEBRAUCHTE BATTERIEN GEMÄß DEN ANWEISUNGEN.



VORBEUGUNG VON HÖRVERLUST

WARNUNG: Das Hören von Musik bei hohen Lautstärkepegeln und über längere Zeiträume kann das Gehör schädigen. Um das Risiko von Hörschäden zu verringern, sollte man die Lautstärke auf ein sicheres, angenehmes Niveau senken und die Zeit, die man bei hohen Pegeln hört, reduzieren. Die Headsets sollten die Anforderungen der EN 50332-2 erfüllen.

FCC-Informationen

ERKLÄRUNG DER BUNDESKOMMUNIKATIONSKOMMISSION

Dieses Gerät wurde getestet und entspricht den Bestimmungen für ein digitales Gerät der Klasse B gemäß Teil 15 der FCC-Bestimmungen. Diese Grenzwerte bieten angemessenen Schutz vor schädlichen Störungen beim Betrieb des Geräts in Wohngebieten. Dieses Gerät erzeugt und verwendet Hochfrequenzenergie und kann diese ausstrahlen. Wenn es nicht gemäß den Anleitung installiert und verwendet wird, kann es Funkstörungen verursachen. Es wird jedoch keinerlei Garantie dafür übernommen, dass die Störungen bei einer bestimmten Installation nicht auftreten. Sollte dieses Gerät den Radio- und Fernsehempfang stören, was sich durch Ein- und Ausschalten des Geräts nachprüfen lässt, wird dem Benutzer empfohlen, zu versuchen, die Störungen durch eine oder mehrere der folgenden Maßnahmen beheben:

- Empfangsantenne neu ausrichten oder verlegen.
- Vergrößern Sie den Abstand zwischen dem Gerät und dem Empfänger.
- Schließen Sie das Gerät an eine Steckdose eines Stromkreises an, der von dem des Empfängers abweicht.
- Fragen Sie den Händler oder einen erfahrenen Radio/Fernsehtechniker um Hilfe.



WARNUNG:

Alle nicht ausdrücklich genehmigten Änderungen oder Modifikationen durch den Erwerber dieses Geräts können die Berechtigung des Benutzers, das Gerät zu bedienen, aufheben.

Informationen zur RF-Exposition [SAR]

Dieses Gerät erfüllt die Anforderungen der Regierung an die Belastung durch Funkwellen. Dieses Gerät ist so konstruiert und hergestellt, dass es die von der Federal Communications Commission der US-Regierung festgelegten Emissionsgrenzwerte für die Belastung durch Radiofrequenzenergie (RF) nicht überschreitet.

Der Expositionsstandard verwendet eine Maßeinheit, die als Spezifische Absorptionsrate oder SAR bekannt ist. Der von der FCC festgelegte SAR-Grenzwert beträgt 1,6 W/kg. Die SAR-Prüfungen werden unter Verwendung der von der FCC akzeptierten Standardbetriebspositionen durchgeführt, wobei der Prüfling mit dem angegebenen Leistungspegel in verschiedenen Kanälen sendet.

Die FCC hat eine Gerätezulassung für dieses Gerät erteilt, wobei alle gemeldeten SAR-Werte als in Übereinstimmung mit den FCC-Richtlinien für HF-Exposition bewertet wurden. Die SAR-Informationen zu diesem Gerät sind bei der FCC hinterlegt und können unter dem Abschnitt Display Grant auf www.fcc.gov/eot/ea/fccid nach einer Suche unter der FCC-ID: 2AKHFAX201NG gefunden werden.

Dieses Gerät entspricht Teil 15 der FCC-Vorschriften. Der Betrieb unterliegt den folgenden zwei Bedingungen:

- [1] dieses Gerät darf keine schädlichen Störungen verursachen, und
- [2] dieses Gerät muss alle empfangenen Störungen aufnehmen, einschließlich Störungen, die den Betrieb beeinträchtigen.



WARNUNG:

Alle nicht ausdrücklich genehmigten Änderungen oder Modifikationen durch den Erwerber dieses Geräts können die Berechtigung des Benutzers, das Gerät zu bedienen, aufheben.

1.2 Sicherheitshinweise



1

Üben Sie keinen starken Druck auf den Computer aus und setzen Sie ihn keinen starken Stößen aus, da dies die Komponenten des Computers beschädigen oder anderweitig zu einer Fehlfunktion führen kann.

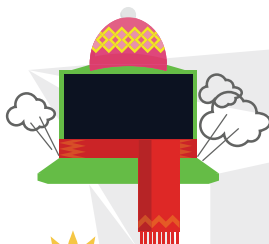

2

Bedecken oder blockieren Sie niemals die Lüftungsschlitze, auch nicht die an der Unterseite des Computers. Decken Sie Ihren Computer oder das Netzteil niemals mit einem Gegenstand ab.

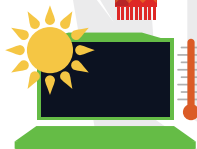

3

Um Ihren Computer in erstklassigem Betriebszustand zu halten, sollten Sie Ihren Arbeitsbereich vor direkter Sonneneinstrahlung schützen.



4

NICHT in der Nähe von Flüssigkeit, Regen oder Feuchtigkeit verwenden.
Das Modem NICHT bei Gewitter verwenden.



5

Benutzen Sie dieses Gerät nicht in der Nähe von magnetischen Feldern oder setzen Sie es diesen nicht aus, da magnetische Störungen die Leistung des Geräts beeinträchtigen können.

1.3 Anmerkungen zu diesem Handbuch



WARNUNG: Diese Mitteilung enthält wichtige Informationen, die für einen sicheren Betrieb beachtet werden müssen.

HINWEIS: Diese Mitteilung enthält Informationen für besondere Situationen.

KAPITEL 2

Kennenlernen der Grundlagen

2.1 Produktbeschreibung

Dieses Benutzerhandbuch enthält technische Kunden-Informationen über Anweisungen und Abbildungen zur Bedienung dieses Notebooks. Bitte lesen Sie diese Anleitung vor der Benutzung des Notebooks sorgfältig durch.

Technische Merkmale	
Abmessungen	356,4mm x 233,73mm x 16,8mm
Gewicht	1,55 kg +/- 5%
Prozessor - CPU	
Support-Prozessors	10. Generation i7 10750H
Grafikkarte - GPU	
Grafikkarte	4 GB GDDR6 nVIDIA® GeForce® GTX 1650
Arbeitsspeicher	
DDR4	DDR4 2933MHz
Speicher	
HDD	2,5" Sata HDD 7mm
SSD	2 Steckplätze (NVMe) M2 2280 Steckplatz 1: NVMe/PCIEX4 Steckplatz 2: NVMe / PCIEX4 / SATAx1 RAID 0/1 Unterstützung
Webkamera	
Webkamera	Ir Webkamera mit D-MICx2

E/A-Anschluss

DC-Eingang	x1
USB	x2 USB 3.1 [Gen1] x1 USB 3.1 Tip C [Gen1] x1 USB 2.0
RJ45	x1
Speicherkartensteckplatz	x1 [SD/SDHC/SDXC]
HDMI	x1
Audioausgang	x1
Mikrofoneingang	x1

Audio

Audio Codec	Azalia-Standardunterstützung, D3-Modusunterstützung, Smart AMP-Unterstützung
Lautsprecher	Build-in 2 speakers [2W / Each]
Mikrofon	Unterstützung für digitale Mikrofone

Eingang

Tastatur	Membrane single RGB backlight support
Zeigegerät	TDA1470 114.5x70x0.8mm

Bildschirm

LCD	15,6" FHD, 16:9 Schmalen Rand
------------	-------------------------------

Kommunikationsanschluss

Lan	10/100/1000 Mb/Sn, PCI-E Schnittstelle, DSM [Deep sleep mode] support
Wireless Lan	M.2 2230 w/ CNVI interface [Intel WiFi6 AX series] IEEE802.11AX mode support,

Leistung

AC Adapter	Automatics Voltage adjustment between 100 and 240V AC 50/60Hz, 90 Watts [19V/4.74A],
Battery	Li- polymer Battery, soft pack, 6 cells [3S2P 7900mAh] 91.24 Wh



WARNUNG:

DAS MODELL IST FÜR DIE VERWENDUNG MIT DER GLEICHSTROMEINGABE: 19V / 4.742A AUSGELEGT.

HINWEIS

Bitte verwenden Sie den Match-Adapter auf der Grundlage der BIOSEinstufung, um Überhitzung und Abnormität des Adapters zu vermeiden.

2.2 Vorbereiten Ihres Computers

- A** Schließen Sie den Gleichstrom-Ausgangsstecker des Netzgerätes an die DC IN Buchse an.



- B** Die Anzeigetafel kann in verschiedenen Winkeln geöffnet werden.

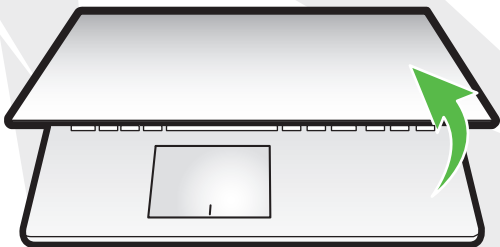

- C** Drücken Sie die Ein-/Austaste, um Ihren Notebook-Computer einzuschalten.

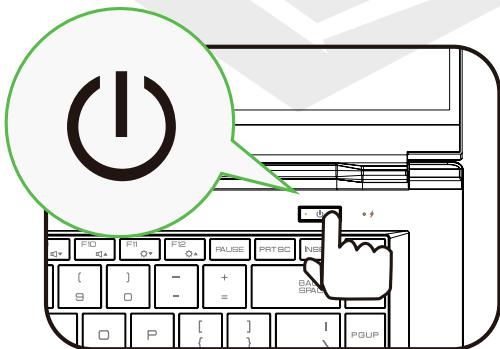

2.3 Produktübersicht

Bitte machen Sie sich mit jedem Bauteil vertraut, bevor Sie den Computer bedienen.

Ansicht Oberseite

HINWEIS

Die Farbe des Produkts, der E/A-Anschluss, die Position der Anzeige und die Ausführung hängen von dem tatsächlich versandten Produkt ab.

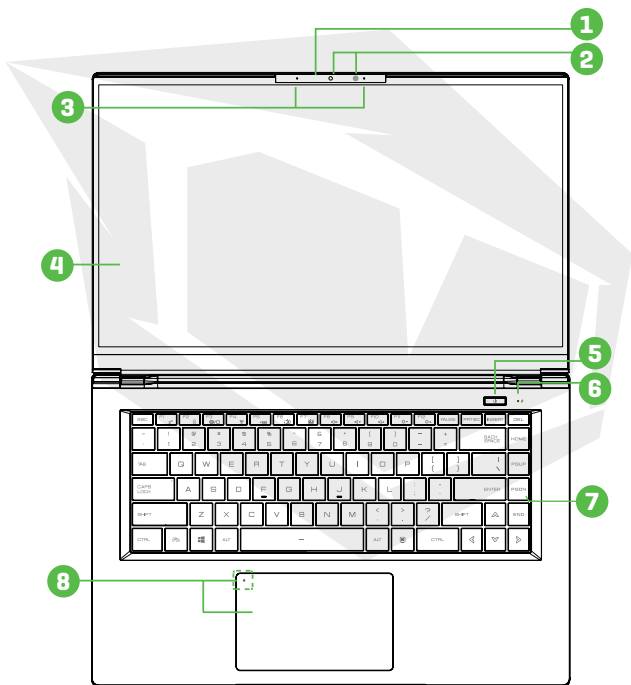

WICHTIG: Wenn Sie den Computer nicht benutzen, halten Sie den LCDBildschirm geschlossen, um ihn vor Staub zu schützen.

1 Camera Status LED

The Camera Status LED zeigt den Kamerastatus an.

2 Webkamera

Die integrierte Kamera ermöglicht, mit Ihrem Computer Videos aufzunehmen oder Fotos zu machen.

Infrarotkamera zur Gesichtserkennung

[optional] Kann zur Identifizierung und Authentifizierung des Benutzers verwendet werden, um das Notebook zu entsperren, Zahlungen und andere Sicherheitsfunktionen durchzuführen.

3 Mikrofon

Eingebautes Mikrofon. IR CCD MIC*2 [Optional]

4 LCD-Bildschirm

Bildschirm Ihres Notebook-Computers.

5 Ein-/Austaste

Drücken Sie diese Taste, um den Computer ein- oder auszuschalten.

Eingeschaltet: Weiß **Ausgeschaltet:** AUS

Ruhezustand: Weiß, gleichmäßig blinkend [3 Sekunden/Zyklus]

6 Lade- & Akkuanzeige

Aufladen [Eingeschaltet]: Weiß **Aufladen [Ausgeschaltet]:** Weiß,

Akku schwach (<6%): Orange [3 Sekunden/Zyklus]

Aufgeladen [am Netzteil]: Weiß, [nicht am Netzteil/Akkumodus]: Aus

7 Tastatur

Die Tastatur besitzt Tasten mit angenehmer Handhabung.

[Die Tastaturlegende hängt von der jeweiligen Spezifikation/Region ab]

8 Touchpad/Clickpad

Berührungsempfindliches Zeigegerät, das wie eine Maus funktioniert.

Touchpad Statusanzeige/ Touchpad-Ein/Aus-Umschalter

Ansicht Vorderseite



Ansicht Unterseite

HINWEIS

Die thermische Entlüftung des Produkts hängt von dem tatsächlich versandten Produkt ab.

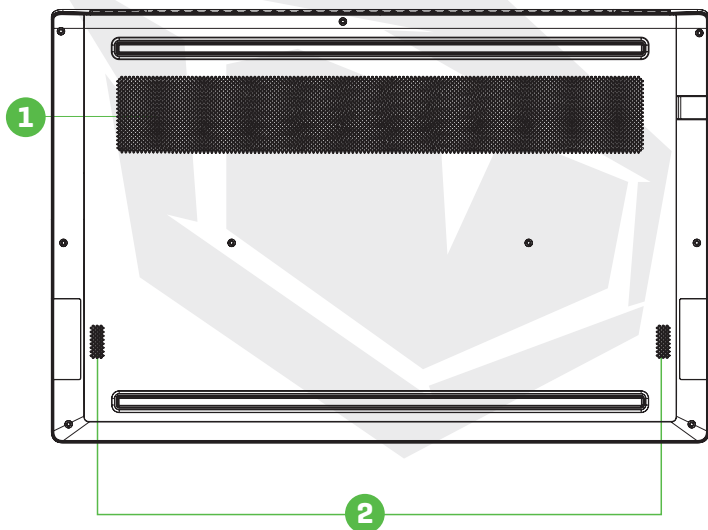

1 Entlüftungsöffnungen

Die thermischen Entlüftungsöffnungen sind so ausgelegt, dass die internen Bauteile gekühlt werden und eine Überhitzung vermieden wird.

2 Lautsprecher

Ansicht HDD / RAM / SSD / WLAN Fach

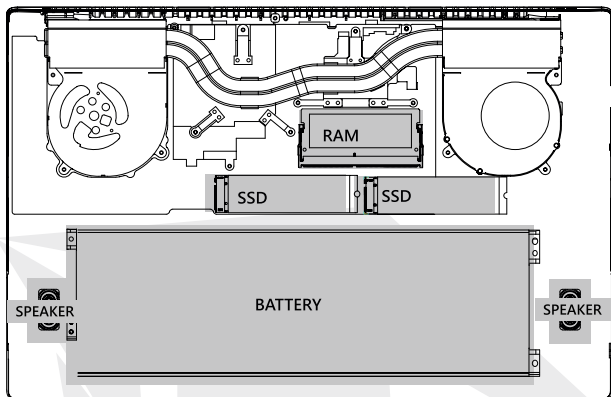

Wenn Sie ein Upgrade von SATA SSD auf PCIE SSD benötigen, wenden Sie sich bitte an den technischen Support und den Kundendienst.



WARNUNG: Möglicherweise hitzebedingte Verletzungen oder einer Überhitzung des Computers zu verringern. Verwenden Sie den Computer nur auf einer harten, ebenen Fläche.

Stellen Sie den Computer nicht direkt auf Ihren Schoß und blockieren Sie nicht die Lüftungsschlitze des Computers, um die

Ansicht rechte Seite



1 USB-Anschlüsse (Typ C)

Unterstützt 90W Typ-C Adapter 19V / 4.7A
Verbindet ein USB-Gerät.

2 USB-Anschlüsse

Verbindet ein USB-Gerät.

3 HDMI-Anschluss

Connected to the screen, or home theater system.

4 Netzanschluss

Stecken Sie das Netzteil in diese Verbindung.

Ansicht linke Seite

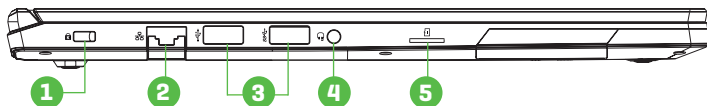

- 1 Kensington® Schloss-Anschluss** 

Mit Kensington® Lock Port Sicherheitsprodukten zu sichern.
- 2 Netzbuchse/LAN-Anschluss**

Über diese Buchse können Sie eine Verbindung zu einem LAN herstellen.
- 3 USB-Anschlüsse**

Verbindet ein USB-Gerät.
- 4 Audioausgang und Mikrofonbuchse** 

Verbindet verstärkte Lautsprecher, Kopfhörer oder Mikrofone mit dieser Buchse.
- 5 Speicherkartensteckplatz** 

Speicherkarte einlegen

Ansicht Rückseite

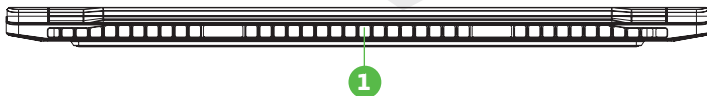

- 1 Entlüftungsöffnungen**

Die thermischen Entlüftungsöffnungen sind so ausgelegt, dass die internen Bauteile gekühlt werden und eine Überhitzung vermieden wird.

KAPITEL 3

Erste Schritte

3.1 AC-Adapter (Netzgerät)

Bitte beachten Sie, dass es dringend empfohlen wird, das Netzteil anzuschließen und den Netzstrom zu verwenden, wenn Sie dieses Notebook zum ersten Mal benutzen. Wenn das Netzteil angeschlossen ist, wird der Akku sofort aufgeladen. Schließen Sie das Netzteil an, wenn Sie den Akku aufladen müssen oder mit dem Netzstrom arbeiten möchten. Dies ist auch der schnellste Weg, da der Akku erst aufgeladen werden muss, bevor Sie mit dem Akku arbeiten können. Beachten Sie, dass das im Paket enthaltene Netzteil für Ihr Notebook zugelassen ist. Die Verwendung eines anderen Adaptermodells kann entweder das Notebook oder andere daran angeschlossene Geräte beschädigen.

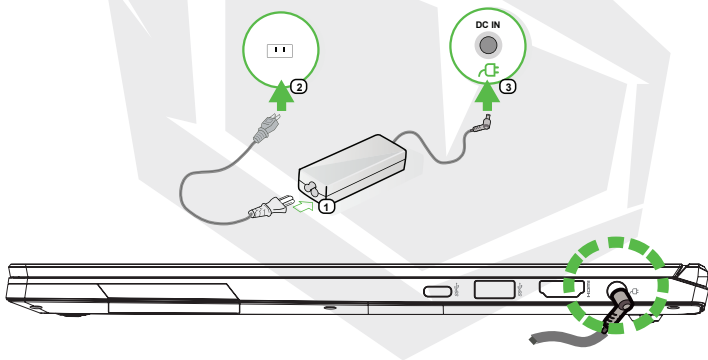

WARNUNG:

Die Verwendung von minderwertigen Verlängerungskabeln kann zu Schäden an Ihrem Notebook führen. Ihr Notebook wird mit einem eigens dafür vorgesehenen Netzteil geliefert. Die Verwendung eines anderen, nicht autorisierten Netzteils oder Verlängerungskabels führt zum Erlöschen des Garantieschutzes, wenn durch deren Benutzung Schäden an der Hardware festgestellt werden.

HINWEIS

Das Netzteil kann bei der Verwendung warm bis heiß werden. Achten Sie darauf, den Adapter nicht abzudecken und ihn vom Körper fernzuhalten. Je nach Region kann Ihr Adapter anders aussehen.

3.2 Die Tastatur kennenlernen

Im Folgenden werden die farbigen Tastenkombinationen auf der Tastatur erläutert. Auf die farbigen Tastenkombinationen kann nur zugegriffen werden, wenn Sie zuerst die Funktionstaste gedrückt halten, während Sie eine Taste mit einem farbigen Befehl drücken.



































HINWEIS

Die Anzahl der auf Ihrer Tastatur verfügbaren Tasten ist regional bedingt und hängt vom jeweiligen Land ab, in dem die Tastatur entwickelt und gebaut wurde.

3.2.1 Für Tastaturbenutzer

Um diese Funktionen zu aktivieren, drücken Sie die der gewünschten Funktion zugeordnete Tastenkombination [siehe unten]:

Tastatur	Funktionsbeschreibung
 +  Ruhezustand:	Drücken Sie diese Tastenkombination [Fn+F1], um in den Schlafmodus zu gelangen.
 +  Windows sperren/entsperren:	Drücken Sie diese Tastenkombination [Fn+F2], um Windows zu sperren oder entsperren.
 +  Anzeigemodus:	Drücken Sie diese Tastenkombination [Fn+F3], um den Anzeigemodus zu aktivieren.
 +  Radio ein/aus:	Drücken Sie diese Tastenkombination [Fn+F4], um alle Radios ein- oder auszuschalten.
 +  Touchpad ein/aus:	Drücken Sie diese Tastenkombination [Fn+F5], um das Touchpad ein- oder auszuschalten.

Tastatur	Funktionsbeschreibung
 +  Tastaturbeleuchtung runter:	Drücken Sie diese Tastenkombination [Fn+F6], um die Helligkeit der Hintergrundbeleuchtung der Tastatur zu verringern.
 +  Tastaturbeleuchtung rauf:	Drücken Sie diese Tastenkombination [Fn+F7], um die Helligkeit der Hintergrundbeleuchtung der Tastatur zu erhöhen.
 +  Lautlos:	Drücken Sie diese Tastenkombination [Fn+F8], um den Lautsprecher ein- oder auszuschalten.
 +  Lautstärke runter:	Drücken Sie diese Tastenkombination [Fn+F9], um die Lautstärke zu verringern.
 +  Lautstärke rauf	Drücken Sie diese Tastenkombination [Fn+F10], um die Lautstärke zu erhöhen.
 +  Helligkeit runter:	Drücken Sie diese Tastenkombination [Fn+F11], um die Helligkeit des LCD-Bildschirms zu verringern.
 +  Helligkeit rauf:	Drücken Sie diese Tastenkombination [Fn+F12], um die Helligkeit des LCD-Bildschirms zu erhöhen.
 +  Suchen-Charm:	Drücken Sie diese Tastenkombination [Windows-Logo-Taste+Q], um die Suchen-Charm und die Suchanwendungen zu öffnen.
 +  Einstellungen-Charm:	Drücken Sie diese Tastenkombination [Windows-Logo-Taste+H], um die Teilen-Charm zu öffnen.
 +  Teilen-Charm:	Press this key combination [Windows logo key+H] to open the share charm.
 +  Geräte-Charm:	Drücken Sie diese Tastenkombination [Windows-Logo-Taste+K], um die Geräte-Charm zu öffnen.

3.3 Verwendung des Touchpads/Clickpads

Das Touchpad/Clickpad ist ein rechteckiges elektronisches Feld, das sich direkt unter Ihrer Tastatur befindet. Sie können das berührungsempfindliche Feld des Touchpads/Clickpads verwenden und darübergleiten, um den Zeiger [Cursor] zu bewegen. Sie können die Tasten unter dem Touchpad als linke und rechte Maustaste verwenden.

Drücken Sie die linke Taste **1** und die rechte Taste **2**, die sich am Rand des Touchpads/Clickpads befinden, um eine Auswahl zu treffen und Funktionen auszuführen. Diese beiden Tasten sind den linken und rechten Tasten einer Maus ähnlich. Das Antippen des Touchpads/Clickpads führt zu den gleichen Ergebnissen.

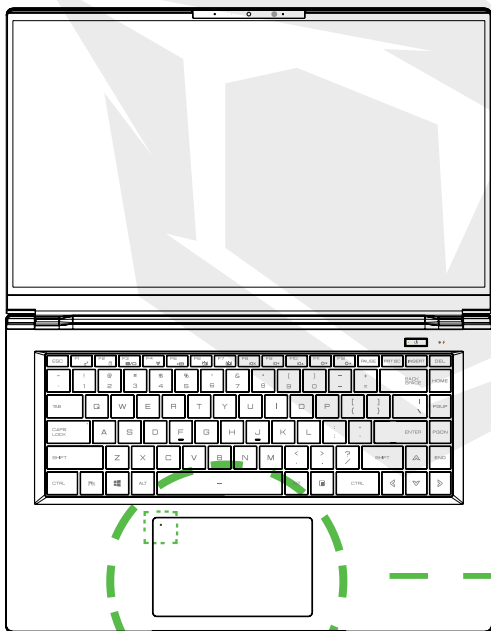

Zweimal in die linke Ecke klicken, aktiviert oder deaktiviert [grünes Licht] die Touchpad-Funktion.

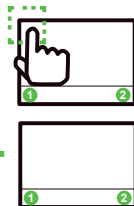

3.3.1 Benutzung des Touchpads

Touchpad Finger-Gesten

Moderne Touchpad Finger-Gesten:

Ein modernes Touchpad sollte die in der folgenden Tabelle beschriebenen grundlegenden Berührungsbewegungen unterstützen.

Element	Gesten Name	Finger-Geste
1	Ein Finger	 Linksklick-Doppelklick
2		 Zeiger bewegen
3		 Tippen+Gleiten
4	Zwei Finger	 Blättern/Schwenken
5		 Verkleinern-Vergrößern
6	Drei Finger	 Multitasking-Geste

KAPITEL 4

Bios Setup

4.1 Über BIOS-Setup

4.1.1 Wann wird das BIOS-Setup verwendet?

Möglicherweise müssen Sie das BIOS-Setup ausführen, wenn:

- Während des Hochfahrens des Systems eine Fehlermeldung auf dem Bildschirm erscheint und Sie aufgefordert werden, das SETUP auszuführen.
- Sie die Standardeinstellungen für kundenspezifische Funktionen ändern möchten.
- Sie die Standard-BIOS-Einstellungen neu laden möchten.

4.1.2 Wie wird das BIOS-Setup ausgeführt?

Um das BIOS-Setup-Dienstprogramm auszuführen, schalten Sie das Notebook ein und drücken Sie während des POST-Vorgangs die Taste [Entf].

Wenn die Meldung verschwindet, bevor Sie antworten, und Sie dennoch das Setup aufrufen möchten, starten Sie entweder das System neu, indem Sie es aus- und einschalten oder gleichzeitig die Tasten [Strg]+[Alt]+[Entf] drücken, um es neu zu starten.

Beachten Sie, dass die Bildschirmfenster und Einstellungsoptionen in diesem Kapitel nur als Referenz dienen. Die tatsächlichen Einstellungsbildschirme und -optionen auf Ihrem Notebook können sich aufgrund der BIOS-Aktualisierung unterscheiden.

Die Setup-Funktion kann nur durch Drücken der Tasten [Entf] oder [F2] während des POST aufgerufen werden. Sie bietet die Möglichkeit, Einstellungen und Konfigurationen nach Benutzer-Vorliebe zu ändern. Die geänderten Werte werden im NVRAM gespeichert und nach dem Neustart des Systems wirksam. Das Setup verwendet eine Menü-Schnittstelle, um dem Benutzer die Möglichkeit zu geben, sein System zu konfigurieren, und die Funktionen werden im Folgenden kurz aufgelistet. Drücken Sie die Taste [F7] für das Boot-Menü.

HINWEIS

Die auf der Support-DVD mitgelieferten Treiber, das BIOS und die Dienstprogramme können je nach Modell variieren und können ohne Vorankündigung geändert werden.

4.2 BIOS-Einrichtungsmenü

Sobald Sie das BIOS-Setup-Dienstprogramm aufrufen, erscheint das Hauptmenü auf dem Bildschirm. Wählen Sie die betreffenden Schlagworte aus, um in die anderen Menüs zu gelangen.

Hauptmenü	Zeigt allgemeine Systeminformationen wie Speichergröße, Systemdatum und -zeit an.
Erweitertes Menü	Um die XD-Funktion auszuwählen, aktivieren oder deaktivieren Sie die XD-Funktion nur mit der Intel-Plattform + Windows
Sicherheits-Menü	Installieren oder löschen Sie die Passworteinstellungen für Vorgesetzte und Benutzer.
Boot-Menü	Konfigurieren von Einstellungen während des Systemstarts
Menü verlassen	Speichern oder verwerfen Sie die Änderungen, bevor Sie das BIOS-Setup-Menü verlassen.

4.2.1 Hauptmenü

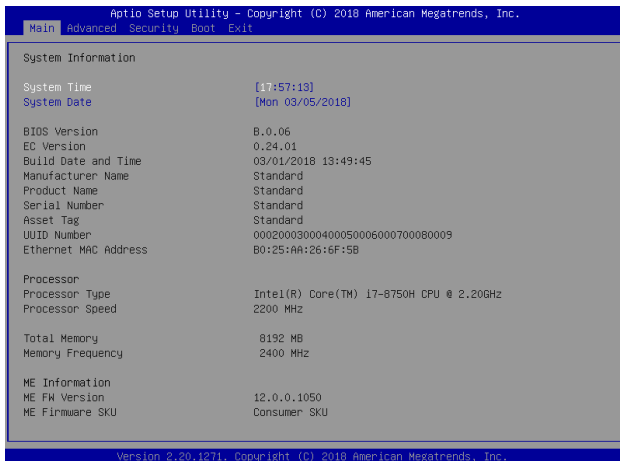

• System-Zeit

Mit diesem Element können Sie die Systemzeit einstellen. Die Systemuhr läuft weiter, unabhängig davon, ob Sie den PC herunterfahren oder in den Schlafmodus gehen. Das Zeitformat ist [Stunde:Minute: Sekunde].

Verwenden Sie [+] oder [-], um die Systemzeit zu konfigurieren.

• System-Datum

Hier können Sie das Systemdatum einstellen. Das Datumsformat ist [Tag:Monat: Datum:Jahr].

Verwenden Sie [ENTER], [TAB] oder [SHIFT-TAB], um einen Bereich auszuwählen.

Tag	Wochentag, von Sonntag bis Samstag, der vom BIOS bestimmt wird [schreibgeschützt].
Monat	[Monat] Der Monat von 01 [Januar] bis 12 [Dezember].
Datum	[Datum] Das Datum von 01 bis 31.
Jahr	[Jahr] Das Jahr kann vom Benutzer eingestellt werden.

• Gesamtspeicher

Erlaubt Ihnen den gesamten Speicherplatz einzusehen.

4.2.2 Erweitertes Menü

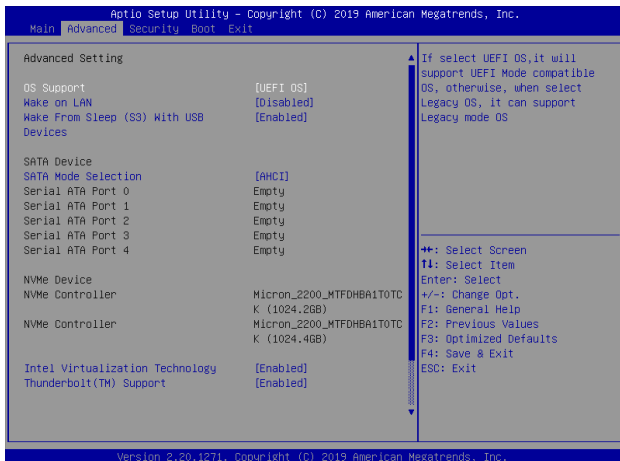

- **Reaktivieren des Ruhezustands [S3] mit USB-Geräten:** Aktivieren/Deaktivieren der Funktion Reaktivieren des Ruhezustands [S3] mit USB-Geräten.
- **Serial-ATA-Festplatte:** Es werden AHCI SATA Festplatten-Informationen angezeigt.
- **NVMe-Gerät:** Zeigt NVMe-Geräte-Informationen an.
- **Intel Virtualisierungstechnik:** Wenn aktiviert, kann ein VMM die von der Vanderpool- Technologie bereitgestellten zusätzlichen Hardware-Funktionen nutzen.
- **RAID-Modus-Erinnerung:** Aktualisieren Sie die Stripe-Größe im BIOS auf 128K, um die RAID-Leistung zu optimieren.
- **Thunderbolt(TM)-Unterstützung:** [Aktiviert/Deaktiviert]
- **Overclocking (Übertakten)-Funktion:** Leistungs Menü für Prozessor und Speicher [Deaktiviert/Aktiviert]
- **Offset-Kernspannung [VCore]:** [50] Gibt die Offset-Spannung an, die an die IA-Core-Domäne angelegt wird. Diese Spannung wird in Millivolt angegeben. Verwendet MSR 0x150, cmd 0x11. Bereich -500 bis 500 mV.
- **XTU-Schnittstelle:** [Aktiviert]
- **Offset-Präfix [+/-]**

4.2.3 Sicherheits-Menü

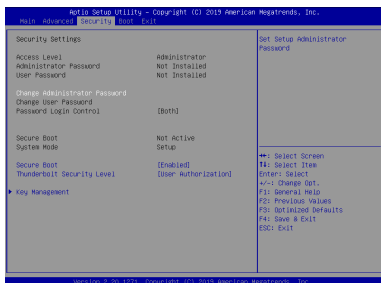

▪ Administrator-Kennwort ändern

Bei Auswahl dieses Punktes sollte folgende Aufforderung auf dem Bildschirm erscheinen:

Neues Kennwort eingeben

- Geben Sie ein maximal 20-stelliges Kennwort ein und drücken die [Eingabetaste] [Enter].
- Das jetzt eingegebene Kennwort ersetzt jedes zuvor festgelegte Kennwort aus dem CMOS-Speicher. Mit [ESC] lässt sich die Einstellung des neuen Kennworts abbrechen. Es ist äußerst wichtig, sich jedes festgelegte BIOS-Kennwort aufzuzeichnen, da es zur Sicherheit Ihres PCs selbst bei Entfernen einer CMOS-Batterie nicht zurückgesetzt werden kann.
- Unter "Benutzerkennwort ändern" verfährt man wie oben unter "Administrator-Kennwort ändern".
- Beachten Sie, dass Benutzer mit dem Administrator-Kennwort Einstellungsänderungen innerhalb des BIOS Setup Utility [System-Konfigurationsprogramms] vornehmen können, während der Zugang über das Benutzer-Kennwort keine Änderungen erlaubt.
- Mittels Password Check wird der Geltungsbereich des BIOS-Passwortschutzes festgelegt.
- Um ein eingerichtetes Administrator-/Benutzer-Kennwort zu löschen, drücken Sie unter „Administrator-Kennwort ändern“/„Benutzer-Kennwort ändern“ die [Eingabetaste] [Enter], wenn Sie zur Eingabe des Kennworts aufgefordert werden. Ein Hinweisfenster bestätigt die Deaktivierung des Kennworts. Danach lässt sich ohne Kennwort-Eingabe der Rechner booten oder das BIOS Setup Programm aufrufen.

▪ Schlüsselverwaltung:

Ermöglicht erfahrenen Benutzern die Änderung von Secure Boot Parametern ohne vollständige Authentifizierung.

4.2.4 Boot Menü

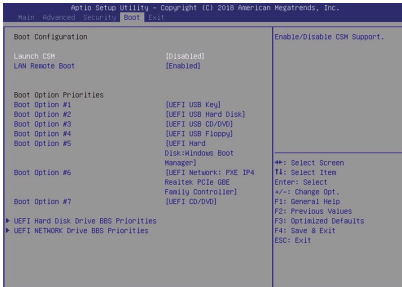

▪ Boot-Konfiguration

Konfigurieren Sie die Einstellungen während des Systemstarts.

▪ LAN-Fernstart [Deaktiviert]

Booten Sie vom LAN aus oder nicht.

▪ Boot-Priorität festlegen

Legt die Boot-Sequenz der verfügbaren Geräte fest. Ein in Klammern gesetztes Gerät wurde im entsprechenden Typmenü deaktiviert.

▪ Festplatte / USB-Festplatte

Legt die Reihenfolge der Boot-Gerätepriorität fest.

4.2.5 Menü verlassen

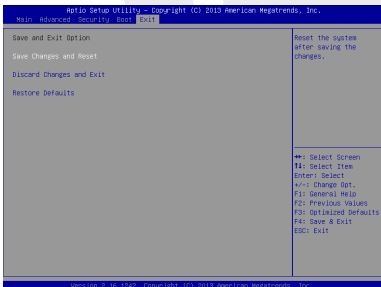

▪ Änderungen speichern und zurücksetzen

Systemeinstellungen verlassen nach Speichern der Änderungen. Die Taste F4 kann für diesen Vorgang verwendet werden.

▪ Änderungen verwerfen und beenden

Systemeinstellungen verlassen, ohne Änderungen zu speichern. Die ESC-Taste kann für diesen Vorgang verwendet werden.

▪ Standardeinstellungen wiederherstellen

Standardwerte für alle Einrichtungsoptionen wiederherstellen/laden. Die Taste F3 kann für diesen Vorgang verwendet werden.

İÇİNDEKİLER

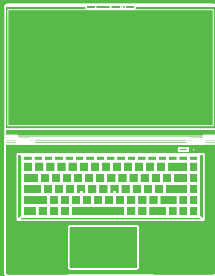

BÖLÜM 1 - Giriş	50
1.1 Yönetmelik Bilgileri	50
FCC Bildirimi	51
RF'ye Maruz Kalma Bilgileri (SAR)	52
1.2 Güvenlik Talimatları	53
1.3 Kılavuz Bilgileri	54
BÖLÜM 2 - Temel Bilgiler	54
2.1 Ürün Özellikleri	54
2.2 Bilgisayarınızın Hazırlanması	56
2.3 Ürüne Genel Bakış	57
BÖLÜM 3 - Başlarken	62
3.1 AC Adaptör	62
3.2 Klavye Tanıtımı	63
3.2.1 Klavye Kullanıcıları İçin	63
3.3 Dokunmatik Paneli ve Tıklama Panelinin Kullanımı	65
3.3.1 Windows 10 Dokunmatik Panel Kullanımı	66
BÖLÜM 4 - Bios Kurulumu	66
4.1 Bios Kurulumu Hakkında	66
4.1.1 Bios Kurulumu Ne Zaman Kullanılır?	66
4.1.2 Bios Kurulumu Nasıl Çalıştırılır?	67
4.2 Bios Kurulum Menüsü	67
4.2.1 Ana Menü	68
4.2.2 Gelişmiş Menü	69
4.2.3 Güvenlik Menüsü	70
4.2.4 Önyükleme Menüsü	71
4.2.5 Çıkış Menüsü	71

HUMA
H5 V2.1

KULLANIM
KILAVUZU

UYARI

Bu kullanım kılavuzundaki bilgiler, telif hakkı kanunları tarafından korunmaktadır. Bu kılavuzun; içinde açıklanan ürünler ve yazılımlar da dahil olmak üzere hiçbir bölümü çoğaltılamaz, iletilemez, kopyası çıkarılamaz, bir bilgi erişim sisteminde depolanamaz veya hiçbir dile çevrilemez.

ÜRETİCİ VEYA SATICI, BU KILAVUZDAKİ HATALAR VEYA EKSİKLİKLERDEN SORUMLU DEĞİLDİR VE BU KULLANIM KILAVUZUNDAKİ BİLGİLERİN HAYATA GEÇİRİLMESİ YA DA KULLANILMASI DURUMUNDA DOĞABİLECEK HASARLARDAN SORUMLU TUTULAMAZ.

Bu kullanım kılavuzundaki çözümler sadece referans amaçlıdır. Asıl ürün özellikleri bölgeye göre değişebilir.

Bu kullanım kılavuzunun içeriği, haber vermeksizin değiştirilebilir.

BÖLÜM 1

Giriş

1.1 Yönetmelik Bilgileri

• CE Uyumlu

Bu cihaz, ev ve ofis kullanımına uygun B sınıfı bir teknik bilgi ekipmanı (ITE) olarak sınıflandırılmaktadır. CE damgası, Avrupa Birliği kurallarına uygun olduğunu onaylar:

- Elektromanyetik Uyumluluk (EMC) Yönetmeliği 2014/30/EU,
- Düşük Voltaj Yönetmeliği 014/35/EU (A2 : 2013'le eşit)
- Radyo Ve Telekomünikasyon Terminal Ekipmanları (R&TTE) Yönetmeliği 2014/53/EU



Bu cihaz en fazla 35°C ortam sıcaklığında çalıştırılabilir. 5°C'den düşük veya 40°C'den yüksek sıcaklıklara maruz bırakmayınız.

DİKKAT:PİLİN YERİNE YANLIŞ PİL TAKILMASI HALİNDE PATLAMA RİSKİ VARDIR LÜTFEN KULLANILMIŞ PİLLERİ TALİMATLARA GÖRE İMHA EDİNİZ



DUYMA KAYBININ ÖNLENMESİ

DİKKAT: Uzun süre boyunca yüksek sesle müzik dinlemek işitme duyusuna zarar verebilir. İşitme hasarı riskini en aza indirmek için kullanıcı ses seviyesini rahat duyabildiği güvenli bir düzeyde tutmalı ve yüksek sesle müzik dinlediği süreyi azaltmalıdır. Kulaklıklar EN 50332-2 gerekliliklerine uymalıdır.

FCC Bildirimi

FEDERAL İLETİŞİM KOMİSYONU PARAZİT BİLDİRİSİ

Bu ekipmanın FCC Kuralları Bölüm 15'te uygun görülen Class B dijital cihazların sınırlarına uygunluğu test edilmiş ve uyumlu bulunmuştur. Bu sınırlar, ev tesisatı içinde parazitlere karşı uygun korumayı sağlamak için belirlenmektedir. Bu ekipman kullanım yaratır, radyo frekans enerjisi yayar ve talimatlara göre kurulup kullanılmadığı takdirde, radyo iletişimlerine zararlı etkilere sebep olabilir. Ancak, bu etkilerin oluşmayacağına garanti edilebileceği herhangi belli bir yüklemeye yoktur. Eğer bu ekipman radyo veya televizyon alıcısında olumsuz bir etkiye sebep olursa, ki bu durum ekipmanın kapatılıp tekrar açılmasıyla tespit edilebilir, kullanıcıya söz konusu etkiyi düzeltebilmesi için aşağıdaki önlemlerden bir veya daha fazlasını alması önerilir.

- Alıcı antenini düzeltmek veya tekrar konumlandırmak.
- Ekipman ile alıcı arasındaki mesafeyi artırmak.
- Ekipman ve alıcının farklı akım devrelerine bağlı olması için ekipmanı farklı bir elektrik çıkışına bağlayın.
- Yardım için ürün satıcısına veya tecrübeli bir radyo/TV teknisyenine danışın.



DİKKAT:

Bu cihazın sahibi tarafından açıkça onaylanmayan herhangi bir değişiklik veya düzenleme kullanıcının ekipmanı kullanma yetkisini geçersiz kılabilir.

RF'ye Maruz Kalma Bilgileri [SAR]

Bu cihaz devletin belirlediği radio dalgalarına maruz kalma oranına uygundur.

Bu cihaz, ABD Hükümeti Federal İletişim Komisyonu tarafından belirlenen radyo frekansı [RF] enerjisine maruz kalma emisyon sınırlarını aşmayacak şekilde tasarlanmış ve üretilmiştir.

Maruz kalma standardı, Özgül Soğurma Oranı veya SAR olarak bilinen bir ölçü birimi kullanır. FCC tarafından belirlenen SAR limiti 1,6 W/kg'dır. SAR testleri, EUT farklı kanallarda belirtilen güç seviyesinde iletim yaparken FCC tarafından kabul edilen standart çalışma konumları kullanılarak gerçekleştirilir.

FCC, bildirilen tüm SAR düzeylerinin FCC RF maruz kalma yönergelerine uygun olarak değerlendirildiği bu cihaz için bir Ekipman Yetkisi verdi. Bu cihazdaki SAR bildirimini, FCC'de dosyalıdır ve www.fcc.gov/eot/ea/fccid'deki Display Grant bölümünde FCC ID: 2AKHFAX201NG araması yapılarak bulunabilir.

Bu cihaz FCC Kurallarınının 15. Bölümü ile uyumludur. İşletim aşağıdaki iki şarta tabidir:

- [1] Bu cihaz zararlı parazite sebep olmaz ve
- [2] Bu cihaz istenmeyen tesirlere sebep olabilecek parazitler de dahil olmak üzere, her türlü parazite karşı açık olmalıdır.



DİKKAT:

Bu cihazın sahibi tarafından açıkça onaylanmayan herhangi bir değişiklik veya düzenleme kullanıcının ekipmanı kullanma yetkisini geçersiz kılabilir.

1.2 Güvenlik Talimatları



1

Bilgisayara çok miktarda baskı uygulamayın veya sert darbelere maruz bırakmayın. Bu, bilgisayarın bileşenlerine zarar verebilir ya da başka arızalara neden olabilir.



2

Bilgisayarın tabanındakiler de dahil olmak üzere hava çıkışlarını asla kapamayın ya da bloke etmeyin. Bilgisayarınızın ya da AC adaptörünüzün üstünü hiçbir şeyle örtmeyin.



3

Bilgisayarınızı en iyi çalışma koşullarında tutmak için, çalışma alanınızı doğrudan güneş ışığından uzak tutun.



4

Sıvıların yakınlarında, yağmurda ya da nemli ortamlarda kullanmayın ve bunlara maruz bırakmayın. Modemi gök gürültülü sağanaklar sırasında kullanmayın.



5

Manyetik alanlar cihazın performansını etkileyebileceğinden, bu cihazı manyetik alanların yakınında kullanmayın.

1.3 Kılavuz Bilgileri



DİKKAT:

Bu mesaj, güvenli kullanım için uyulması gereken bilgiler içermektedir.

NOT: Bu mesaj, özel durumlar için gereken bilgiler içerir.

BÖLÜM 2

Temel Bilgiler

2.1 Ürün Özellikleri

Bu Kullanım Kılavuzu, müşterinin dizüstü bilgisayarını nasıl çalıştıracaklarını açıklayan teknik bilgiler ve çözümler içerir.

Fiziksel Özellikler	
Boyutlar	356,4mm x 233,73mm x 16,8mm
Ağırlık	1,55 kg +/- 5%
İşlemci - CPU	
İşlemci	10. Generation i7 10750H
Ekran Kartı - GPU	
Ekran Kartı	4 GB GDDR6 nVIDIA® GeForce® GTX 1650
Bellek	
DDR4	DDR4 2933MHZ
Depolama	
Sabit Disk	2,5" Sata HDD, 7mm
SSD	2 Slot (NVMe) M2 2280 Birinci depolama yeri: NVMe/PCIEX4 İkinci depolama yeri: NVMe/PCIEX4/SATAx1 RAID 0/1 Desteği
Web Kamerası	
Web Kamerası	Kızılötesi HD web kamerası D-MICx2

Giriş - Çıkış Portları

Güç Girişi	x1
USB	x2 USB 3.1 (Gen1) x1 USB 3.1 Tip C (Gen1) x1 USB 2.0
RJ45	x1
Kart Okuyucu	x1 [SD/SDHC/SDXC]
HDMI	x1
Ses Çıkışı	x1
Mikrofon Girişi	x1

Ses

Ses Kodeği	Azalia standart desteği, D3 modu desteği, Smart AMP support
Hoparlör	Dahili 2 hoparlör [Her biri 2W]
Mikrofon	Kamera yanı dijital mikrofon

Giriş

Klavye	Arka ışık destekli Klavye
İşaretçi	Dokunmatik panel 1470 114.5x70x0.8mm

Ekran

LCD	15,6" FHD, 16:9 ince çerçeve ekran
------------	------------------------------------

İletişim Portları

Lan	10/100/1000 Mb/Sec Destekli, PCI-E arayüzü, DSM [Deep sleep mode] Desteği
Kablosuz Lan	M.2 2230 w/ CNVI arayüzü [Intel WiFi6 AX series] IEEE802.11AX mod desteği.

Güç

AC Adaptör	Automatics Voltage adjustment between 100 and 240V AC 50/60Hz, 90 Watts [19V/4,74A], 3 Pins-GK5MP5V/GK5MRVF
Batarya	Li- polymer Battery , soft pack, 6 cells [3S2P 7900mAh] 91.24 Wh



DİKKAT:

BU MODEL, 19V / 4,74A DC GİRİŞ İLE KULLANILMAK ÜZERE TASARLANMIŞTIR.

NOT

Fazla ısınmayı ve adaptörün bozulmasını engellemek için lütfen BIOS derecesine göre uygun adaptör ile kullanın.

2.2 Bilgisayarınızın Hazırlanması

- A** AC adaptörün DC çıkış kablosunu bilgisayarın DC girişine bağlayın.

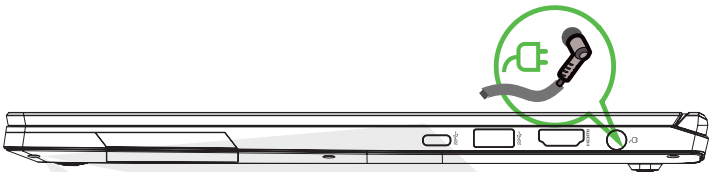

- B** Ekran paneli, en uygun görüntüleme için pek çok açıda açılabilir.

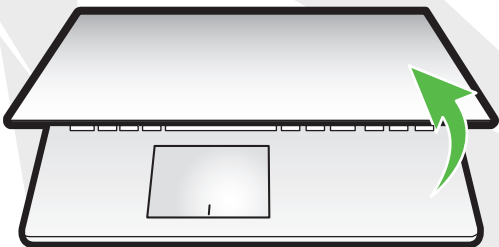

- C** Dizüstü bilgisayarınızı açmak için güç düğmesine basın.

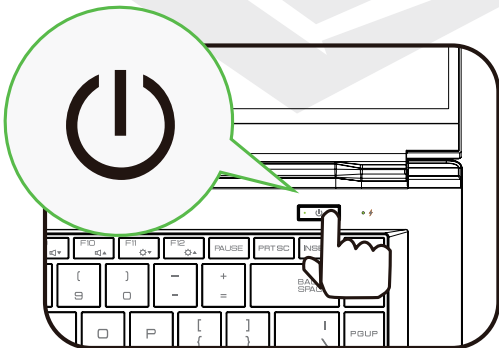

2.3 Ürüne Genel Bakış

Lütfen bilgisayarı çalıştırmadan önce her bileşeni tanıyınız.

Tepeden-Açık Görünüm

NOT Ürünün rengi, I/O portu, göstergelerinin yerleri ve özellikleri, satın alınmış olan asıl ürüne göre değişiklik gösterecektir.

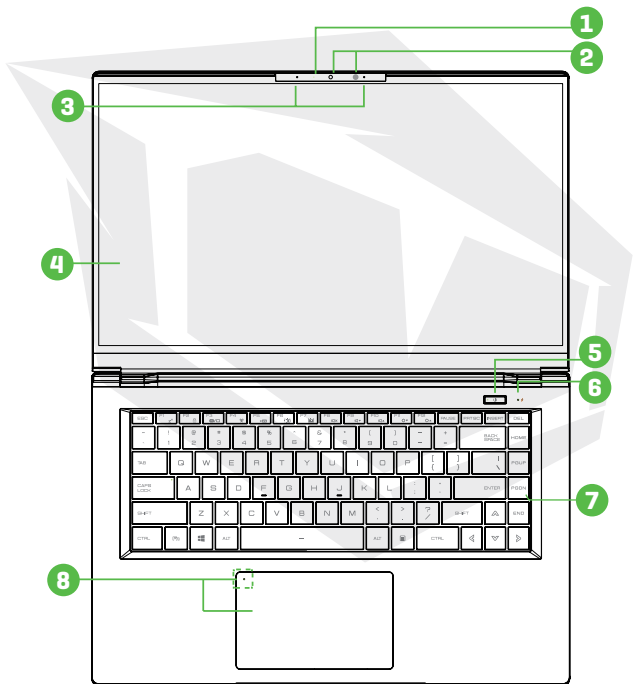

DİKKAT:

Bilgisayarı kullanmadığınız zamanlarda, LCD ekranı tozdan korumak için kapalı tutun.

1 Kamera Durumu LED'i

Kameranın durumunu [açık-kapalı] gösterir.

2 Web Kamerası

Bilgisayarınızla video kaydetmenizi ya da fotoğraf çekmenizi sağlayan bir aygıt.

İnfraredli yüz tanıma kamerası

[Opsiyonel] Notebook kilidini açmak için kullanıcı tanımlamak ve kimlik doğrulaması için kullanılabilir. Ödeme ve diğer güvenlik fonksiyonlarını yerine getirir.

3 Mikrofon

Yerleşik Mikrofon. IR CCD MIC*2[Optional]

4 LCD Ekran

Dizüstü bilgisayarınızın ekranı

5 Güç Düğmesi

Bilgisayarınızı açıp kapamak için bu düğmeye basın.

Güç Açık: Beyaz **Güç Kapalı:** Kapalı

Beklemede: Beyaz, Yavaş/Düz, Yanıp Sönen Beyaz [3sn/Döngü]

6 Şarj ve Pil Göstergesi

Şarjda [Güç Açık]: Beyaz **Şarjda [Güç Kapalı]:** Beyaz,

Pil Zayıf [<%6]: Turuncu [3sn/Döngü]

Şarj Bitti [w/AC]: Beyaz, [w/o AC]: kapalı

7 Klavye

Klavye rahat bir şekilde elinizi hareket ettirmenize imkan tanır.

[Klavye açıklaması özellik ve ülkeye göre değişiklik gösterecektir.]

8 Dokunmatik panel/Tıklama paneli

Dokunmaya duyarlı, fare fonksiyonlu işaretleme aygıtı.

Touchpad LED göstergesi/Touchpad anahtarı

Önden Görünüş



Alttan Görünüş

NOT

Ürünün ısı çıkışları, satın alınmış olan asıl ürüne göre değişiklik gösterecektir.

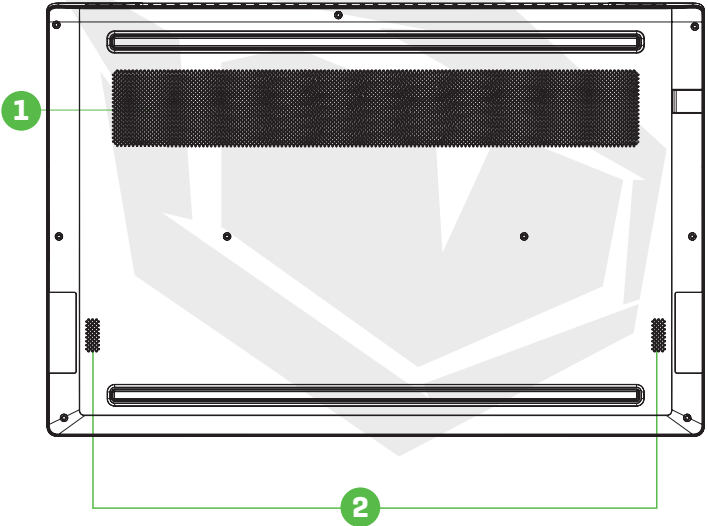

1 Hava Çıkışları

Termal hava çıkışları, dahili bileşenleri soğutmak ve aşırı ısınmayı önlemek için tasarlanmıştır.

2 Hoparlörler

HDD / RAM / SSD / WLAN Bölme Görünümü

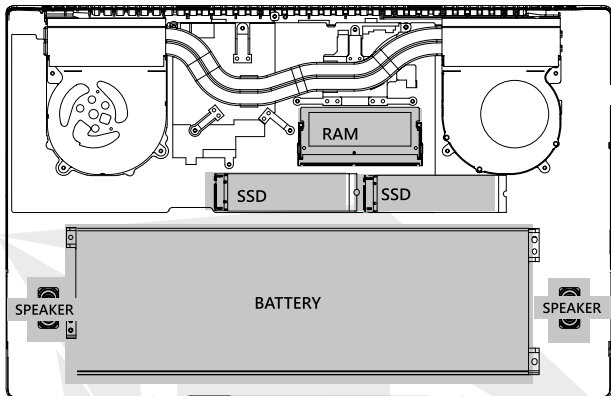

SATA SSD'yi veya PCIE SSD'yi yükseltmeniz gerekirse lütfen teknik destek ve satışı sonrası servisle iletişime geçin.

**DİKKAT:**

Bilgisayarı kullanmadığınız zamanlarda, LCD ekranı tozdan korumak için kapalı tutun.

Sağdan Görünüş

**1** USB Girişi [Tip-C] 

90W C Tipi Adaptör 19V / 4.7A desteği
Bir USB cihazı bağlar.

2 USB Girişi 

Bir USB cihazı bağlar.

3 HDMI Girişi 

Yüksek çözünürlüklü dijital video bağlantılarını destekler.

4 Güç Bağlantısı 

AC adaptörü bu bağlantıya takın.

Soldan Görünüş

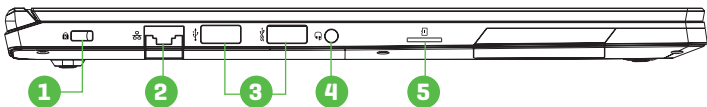

- 1 Kensington® Kilidi** 

Kensington® Kilidi ile cihazınızı güvence altına alın.
- 2 Ağ Bağlantısı** 

Bu giriş ağa bağlanmanızı sağlar.
- 3 USB Girişi** 

Bir USB cihazı bağlar.
- 4 Ses Çıkış Jaki ve Mikrofon Jaki** 

Amplifikatörlü hoparlörler, kulaklıklar ya da mikrofon bu jake takılır.
- 5 Kart Okuyucu** 

Hafıza kartı takılır.

Arkadan Görünüş

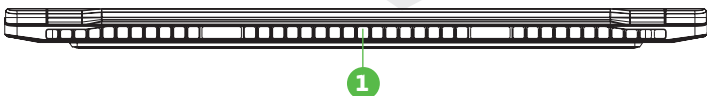

- 1 Hava Çıkışları**

İşlemcinin aşırı ısınmasını engellemek için dışarı sıcak hava veren çıkışlar.

BÖLÜM 3

Başlarken

3.1 AC Adaptör

Dizüstü bilgisayarını ilk kez kullanacaksanız, AC adaptörü bağlayarak şebeke elektriği kullanmanız mutlaka önerilmektedir. AC adaptör bağlıyken, pil hemen şarj olmaya başlar. AC adaptörü pili şarj etmek ya da bilgisayarını şebeke elektriğine bağlı olarak kullanmak istediğinizde takın. Ayrıca bilgisayarını kullanmaya başlamanın en hızlı yolu budur, çünkü bilgisayarını pil gücüyle çalıştırabilmek için pilin şarj edilmesi gerekmektedir.

Lütfen bilgisayarınızla kullanmaya uygun olan adaptörün, paketten çıkan adaptör olduğunu unutmayın. Başka bir adaptör modeli kullanmak bilgisayara ya da bilgisayara bağlı olan cihazlara zarar verebilir.

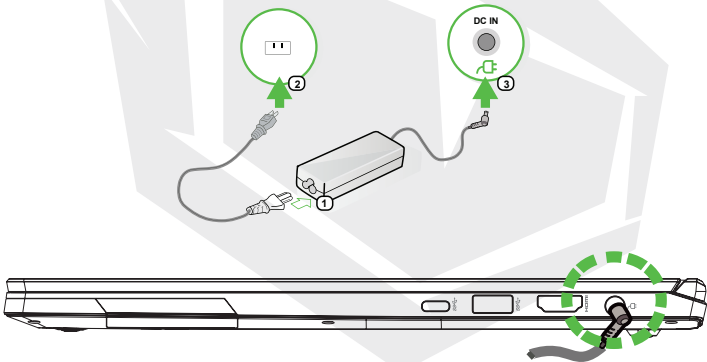

DİKKAT:

Kalitesiz uzatma/bağlantı kablolarının kullanımı bilgisayara zarar verebilir. Bilgisayarınız kendi, onaylı AC adaptörü ile birlikte gelir. Onaylı olmayan AC adaptör veya uzatma kablosunun kullanımından doğan donanım hasarları garantiyi geçersiz kılar.

NOT

Güç adaptörü, fişe takılıyken ısınabilir. Adaptörün üstünü örtmeyin ve vücudunuzdan uzak tutun. Adaptörünüzün görünümü, yaşadığınız bölgeye göre değişiklik gösterebilir.

3.2 Klavye Tanıtımı

Aşağıda, klavyedeki renkli kısayol tuşları anlatılmaktadır.

Renkli komutlara erişmek için önce Function [Fn] tuşuna basılı tutarak ardından renkli bir komut tuşuna basılmalıdır.

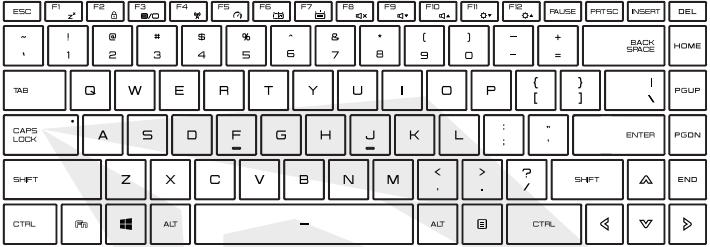























NOT

Klavyenizdeki tuş sayısı, bilgisayarınızın konfigüre edildiği ülkeye/bölgeye göre değişiklik gösterebilir.

3.2.1 Klavye Kullanıcıları İçin

Aşağıdaki fonksiyonları etkinleştirmek için, kullanmak istediğiniz fonksiyonun düğmesine aşağıda anlatılan şekilde basın.

Tuşlar	Fonksiyon Açıklaması
 +  Bekleme:	Bilgisayarı uyku moduna geçirmek için bu tuş kombinasyonuna (Fn+F1) basın.
 +  Windows Kilitle/Aç:	Windows Kilitle/Aç'ı etkinleştirmek için bu tuş kombinasyonuna (Fn+F2) basın.
 +  Ekran Modu:	Ekran moduna geçmek için bu tuş kombinasyonuna (Fn+F3) basın. Ekran Modu'nu değiştirir.
 +  Wi-Fi Aç/Kapat:	Tüm kablosuz bağlantı aygıtlarını kapamak için bu tuş kombinasyonuna (Fn+F4) basın.
 +  Dokunmatik Panel:	Dokunmatik panel moduna geçmek için bu tuş kombinasyonuna (Fn+F5) basın.

Tuşlar	Fonksiyon Açıklaması
 +  Klavye Parlaklığı Azaltma:	Klavye ışıklarının parlaklığını azaltmak için bu tuş kombinasyonuna [Fn+F6] basın.
 +  Klavye Parlaklığı Artırma:	Klavye ışıklarının parlaklığını artırmak için bu tuş kombinasyonuna [Fn+F7] basın.
 +  Ses Kapat:	Sesi tamamen kapamak için bu tuş kombinasyonuna [Fn+F8] basın.
 +  Ses Kıs:	Sesi kısmak için bu tuş kombinasyonuna [Fn+F9] basın.
 +  Sesi Aç:	Sesi yükseltmek için bu tuş kombinasyonuna [Fn+10] basın.
 +  Ekran Işığı Kıs:	LCD ekranın parlaklığını azaltmak için bu tuş kombinasyonuna [Fn+11] basın.
 +  Ekran Işığı Aç:	LCD ekranın parlaklığını artırmak için bu tuş kombinasyonuna [Fn+12] basın.
 +  Arama Düğmesi:	Arama düğmesini ve arama uygulamalarını açmak için bu tuş kombinasyonuna [Windows logosu tuşu+Q] basın
 +  Ayarlar Düğmesi:	Ayarlar düğmesini açmak için bu tuş kombinasyonuna [Windows logosu tuşu+Q] basın.
 +  Paylaşım Düğmesi:	Paylaşım düğmesini açmak için bu tuş kombinasyonuna [Windows logosu tuşu+H] basın.
 +  Cihazlar Düğmesi:	Cihazlar düğmesini açmak için bu tuş kombinasyonuna [Windows logosu tuşu+K] basın.

3.3 Dokunmatik Paneli ve Tıklama Panelinin Kullanımı

Dokunmatik yüzey/tıklama yüzeyi, klavyenizin hemen altında bulunan, dikdörtgen şeklinde, elektronik bir paneldir. Statik elektriğe hassas olan bu panelde kaydırma hareketleriyle imlecini hareket ettirebilirsiniz. Dokunmatik yüzeyin altındaki düğmeleri sağ ve sol fare tuşları gibi kullanabilirsiniz.

Dokunmatik panelin/tıklama panelinin altındaki **1** ve **2** numaralı düğmeleri kullanarak seçim yapabilir ve fonksiyonları devreye sokabilirsiniz. Dokunmatik panele/tıklama paneline dokunarak da aynı şeyi yapabilirsiniz.

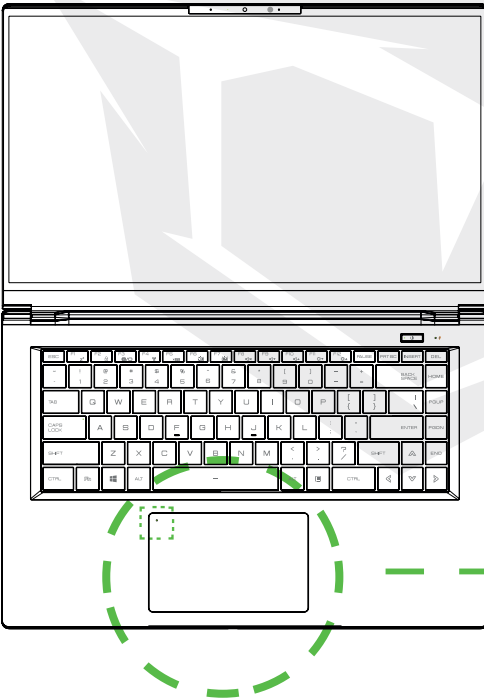

Dokunmatik paneli açmak için, sol üste iki kere dokunun

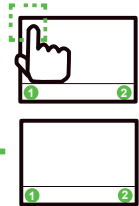

3.3.1 Windows 10 Dokunmatik Panel Kullanımı

Dokunmatik Panel hareketleri

Modern dokunmatik panel hareketleri:

Modern bir dokunmatik panel, aşağıdaki tabloda gösterilen temel el hareketlerini desteklemelidir.

Öge	Hareket Adı	Hareket
1	Tek Parmak	 Sol Tıklama - Çift Tıklama
2		 İmleci Hareket Ettirme
3		 Dokunup Kaydırma
4	İki Parmak	 Kaydırma
5		 Yaklaştırma - Uzaklaştırma
6	Üç Parmak	 Çoklu Görev Hareketi

BÖLÜM 4

Bios Kurulumu

4.1 Bios Kurulumu Hakkında

4.1.1 Bios Kurulumu Ne Zaman Kullanılır?

Aşağıdaki durumlarda BIOS Kurulumunu çalıştırmanız gerekebilir:

- Sistem açılırken ekranda bir hata mesajı çıktığında ve kurulum'un çalıştırılması istendiğinde.
- Kişiselleştirilmiş özelliklerin geçerli ayarlarını değiştirmek istediğinizde.
- Geçerli BIOS ayarlarını yeniden yüklemek istediğinizde.

4.1.2 Bios Kurulumu Nasıl Çalıştırılır?

BIOS Kurulum Yardımcı Programı'nı çalıştırmak için, dizüstü bilgisayarını açın ve POST işlemi sırasında [Del] tuşuna basın.

Mesaj siz tuşa basmadan kaybolursa ve Kurulum'a yine de girmek istiyorsanız, sistemi Kapatıp Açarak ya da [Ctrl]+[Alt]+[Del] tuşlarına aynı anda basarak yeniden başlatın.

Bu bölümdeki ekran görüntülerinin ve seçeneklerin sadece genel referans amaçlı olduğunu unutmayın. Bilgisayarınızdaki asıl ekranlar ve seçenekler, BIOS versiyonunuzdan dolayı farklı görünebilir.

Kurulum işlevi sadece POST sırasında [Del] ya da [F2] tuşlarına basarak açılabilir. Bu işlev, bazı ayarları ve konfigürasyonların kullanıcının tercih ettiği şekle getirilmesini sağlar. Değiştirilen değerler NVRAM'e kaydedilir ve bilgisayar yeniden başladığında devreye girer. Kurulum, kullanıcının sistemini konfigüre etmesini sağlar. Özellikleri aşağıda kısaca açıklanmıştır. Önyükleme Menüsü için [F7]'ye basın.

NOT

Destek USB belleğinde gelen sürücüler, BIOS ve yardımcı programlar modele göre değiştirilebilir ve duyuru yapılmaksızın değiştirilebilir.

4.2 Bios Kurulum Menüsü

BIOS Kurulumu Yardımcı Programı'na girdiğinizde, ekranda Ana Menü görüntülenecektir. Diğer menülere girmek için etiketleri seçin.

Ana Menü	Bellek boyutu, sistem tarihi ve saati gibi genel sistem bilgilerini gösterir.
Gelişmiş Menü	XD özelliğini seçmek bu özelliği devreye sokar ya da devreden çıkarır. XD özelliği sadece Intel platformu ve Windows'ta çalışır.
Güvenlik Menüsü	Yönetici ve kullanıcı için şifre ayarlarını değiştirir ya da siler.
Önyükleme Menüsü	Sistem Önyüklemesi'yle ilgili ayarlar.
Menüden Çıkış	BIOS Kurulum Menüsü'nden çıkmadan önce değişiklikleri kaydetmek ya da kaydetmeden çıkmak için.

4.2.1 Ana Menü

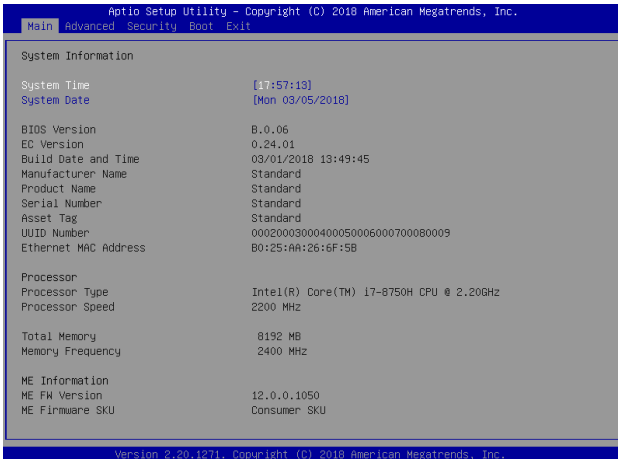

• Sistem Saati

Bu öge sistem saatini ayarlamanızı sağlar. Sistem saatinizi korumak için tasarlanmış küçük bir dahili [CMOS] pil vardır. Bilgisayar kapatıldığında veya uyku modundayken bile zamanı korumak için tasarlanmıştır. Saat biçimi [saat: dakika: saniye] şeklindedir.

Sistem saatini ayarlamak için [+] ya da [-] kullanın.

• Sistem Tarihi

Bu seçenek, sistem tarihini ayarlamanızı sağlar. Tarih formatı [gün adı:ay:gün:yıl] şeklindedir. Bir alanı seçmek için [ENTER]'a, [TAB]'a ya da [SHIFT-TAB]'a basın.

Gün

Haftanın, Pazartesi-Pazar arası bir günü. BIOS tarafından belirlenir, değiştirilemez.

Ay

01'den [Ocak] 12'ye [Aralık] bir ay.

Tarih

Ayın 01-31 arası bir günü.

Yıl

Yılı kullanıcı ayarlayabilir.

• Toplam Bellek

Toplam bellek miktarını görmenize olanak tanır.

4.2.2 Gelişmiş Menü

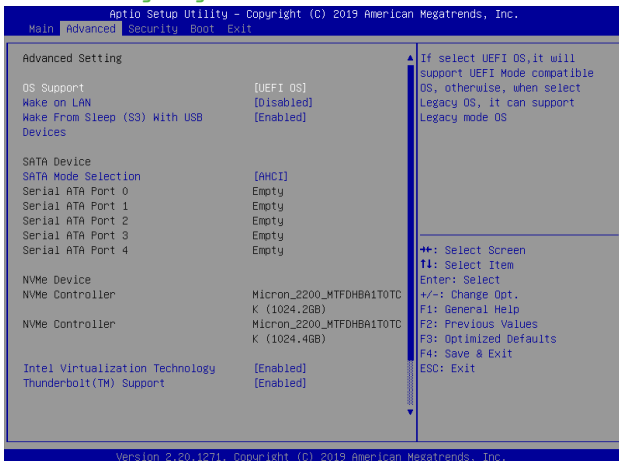

- **Uyandır [S3] USB Aygıtları ile:** Etkinleştir/Devredışı bırak uyandır [S3] USB cihazları ile.
- **Seri ATA HDD:** AHCI SATA HDD bilgilerini gösterir.
- **NVMe Device:** NVMe aygıt bilgilerini gösterir.
- **Intel Sanallaştırma Teknolojisi:** Devreye sokulduğunda, bir VMM, Vanderpool Technology tarafından sağlanan ek donanım imkânlarını kullanabilir.
- **RAID mod hatırlatıcı:** RAID'in performansı optimize etmesi için lütfen BIOS'ta şerit boyutunu 128K olarak güncelleyin.
- **Thunderbolt (TM) Desteği :** [Etkinleştir/Devre Dışı Bırak]
- **OverClocking Özelliği:** İşlemci ve hafıza için performans menüsü [Etkinleştir/Devre Dışı Bırak]
- **Çekirdek Voltaj Dengesi:** [50] IA Çekirdek etki alanına uygulanan Ofset Voltajını belirtir. Bu voltaj milivolt cinsinden belirtilir. Bu voltaj milivolt olarak gösterilir. MSR 0x150, cmd 0x11 posta kutusunu kullanır. Aralık-500 to 500 mV.
- **XTU Arayüz:** [Etkin]
- **Offset Prefix [+/-]**

4.2.3 Güvenlik Menüsü



• Yönetici Şifresini Değiştir

Bu öge seçildiğinde, ekranda aşağıdaki gibi bir mesaj kutusu görünecektir:

Yeni Şifre Girin

- Maksimum 20 karakterli bir şifre girin ve [Enter] tuşuna basın.
- Şimdi yazılan şifre, CMOS belleğinden önceden ayarlanmış şifrelerin yerini alacak. Yeni şifre ayarından vazgeçmek için [ESC] tuşuna da basabilirsiniz. Bilgisayarınızın güvenliği için bir CMOS pilinin çıkarılmasıyla bile sıfırlana mayacağı için ayarlanan herhangi bir BIOS şifresi için kayıt tutmak son derece önemlidir.
- Yönetici Parolası alanının kullanıcıların BIOS KURULUMU YARDIMCI PROGRAMI ayarlarını girmesine ve değiştirmesine izin verdiğini unutmayın. Kullanıcı Parolası alanı, kullanıcıların herhangi bir değişiklik yapma yetkisine sahip olmadan BIOS KURULUMU YARDIMCI PROGRAMI'na girmesine izin verir.
- Parola Denetimi ögesi, uygulanan BIOS parola koruması türünü belirtmek için kullanılır.
- Belirlenmiş bir Yönetici/Kullanıcı parolasını silmek için parolayı girmeniz istendiğinde Yönetici/Kullanıcı Parolasını Değiştir alanına şifrenizi girip [Enter] tuşuna basmanız yeterli.

Tuş Yönetimi:

Uzman kullanıcının, tam kimlik doğrulaması yapmadan Güvenli Önyükleme İlkesi değişkenlerini değiştirmesini sağlar.

4.2.4 Önyükleme Menüsü

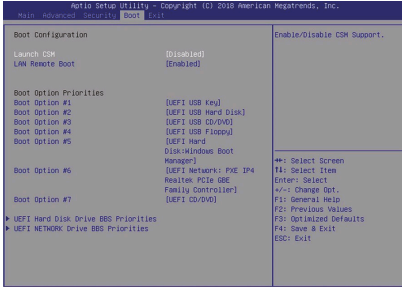

- **Önyükleme Konfigürasyonu:** Sistem Önyüklemesi ayarlarını düzenleyin.

- **LAN'dan Uzaktan Başlatma [Kapalı]:** LAN üstünden bilgisayarın başlatılmasını ayarlar.

• Önyükleme Önceliğini Ayarla:

Bilgisayarın mevcut cihazlardan hangisinden başlatılacağıнын sırasını ayarlar. Parantez içindeki cihaz, ilgili menüde devre dışıdır.

• Sabit Disk / USB Sabit Disk:

Önyükleme Cihazı Önceliği sıralamasını belirtir.

4.2.5 Çıkış Menüsü

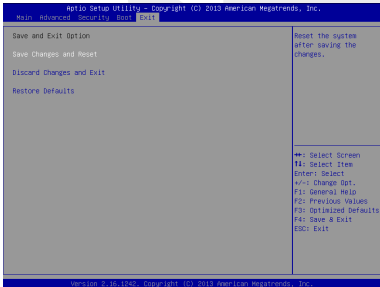

• Değişiklikleri Kaydet ve Yeniden Başlat:

Değişiklikleri kaydedip sistem kurulumundan çıkar. F4 tuşuyla yapılabilir.

• Değişiklikleri Kaydetmeden Çık:

Yaptığınız değişiklikleri kaydetmeden sistem kurulumundan çıkış. ESC tuşuyla yapılabilir.

• Geçerli Ayarlara Dön:

Tüm Kurulum seçeneklerini geçerli ayarlara geri döndürür. F3 tuşuyla yapılabilir.



TURKEY · UAE · CYPRUS · GERMANY